



LAPAFIL

CATÁLOGO 65



LAPAFIL IN T



LAPAFIL

THE WORLD

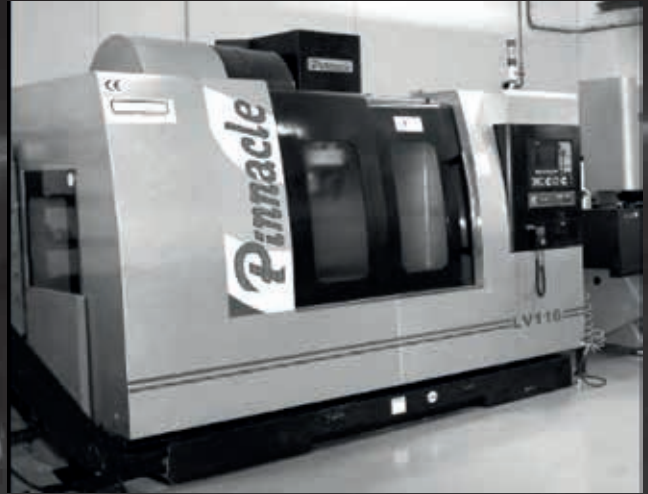
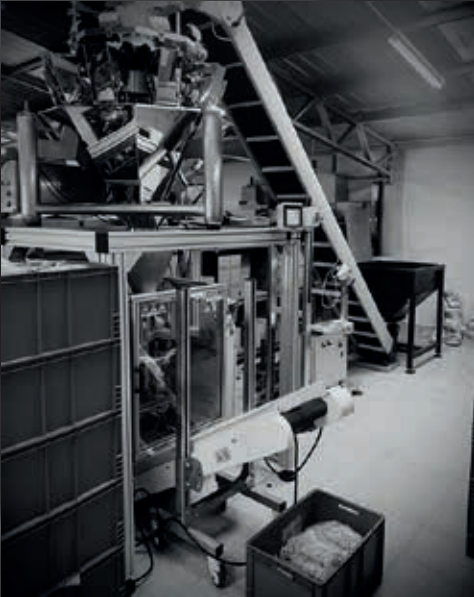

Lapafil: is a family owned company founded in 1955 in Barcelona and dedicated since the beginning to the manufacture of fixing systems. We started our business with the invention of the plastic clip for cables and have now more than 2.000 references in our catalogue thanks to constant innovations and finding solutions to our market needs.

Today, we manufacture a large range of nylon products such as clamps for pipes, plugs, cable ties, glazing blocks for windows and much more.....

In 2003 we started production of metallic pieces, including new products progressively such as metallic anchors, metallic clips, and others. Since its beginnings, Lapafil has known a constant growth , and is now a reference in Spain as well as in Europe with exports to five continents.

At Lapafil we also manufacture our own injection molds and matrix and we count on a very professional team dedicated to innovation who create from the first customer idea or design, a complete final new project.

As a family business and thanks to our comercial team who give an excellent insight of market needs, we work for Lapafil growth without losing proximity to our customers.

Lapafil: somos una empresa familiar, fundada en 1955 en Barcelona, fabricantes desde su inicio de sistemas de fijación. Empezamos inventando la grapa de plástico para cable eléctrico, el famoso "GRAPILLÓN", y actualmente con más de 2.000 referencias de producto en nuestro catálogo, seguimos innovando y solucionando todas las necesidades de nuestro mercado.

Actualmente fabricamos muchas familias de piezas de Nylon, tales como Abrazaderas para tubos, Tacos, Bridas, Calzos para ventanas,...

En 2003 empezamos con la producción de piezas metálicas, fabricando nuevos productos progresivamente, como los anclajes metálicos, grapas de 1 y 2 patas, ... y a día de hoy nos encontramos en pleno crecimiento y somos un fabricante referente en España y Europa, exportando a los cinco continentes.

En Lapafil, fabricamos nuestros propios moldes de inyección y matrices, y contamos con un gran equipo de profesionales dedicados a innovación, que realizan desde el primer boceto o diseño, hasta la finalización de los nuevos proyectos.

Siendo aún una empresa familiar, y gracias a nuestra red comercial que nos aporta todas las necesidades del mercado, trabajamos para ir creciendo sin perder la proximidad con nuestros clientes.



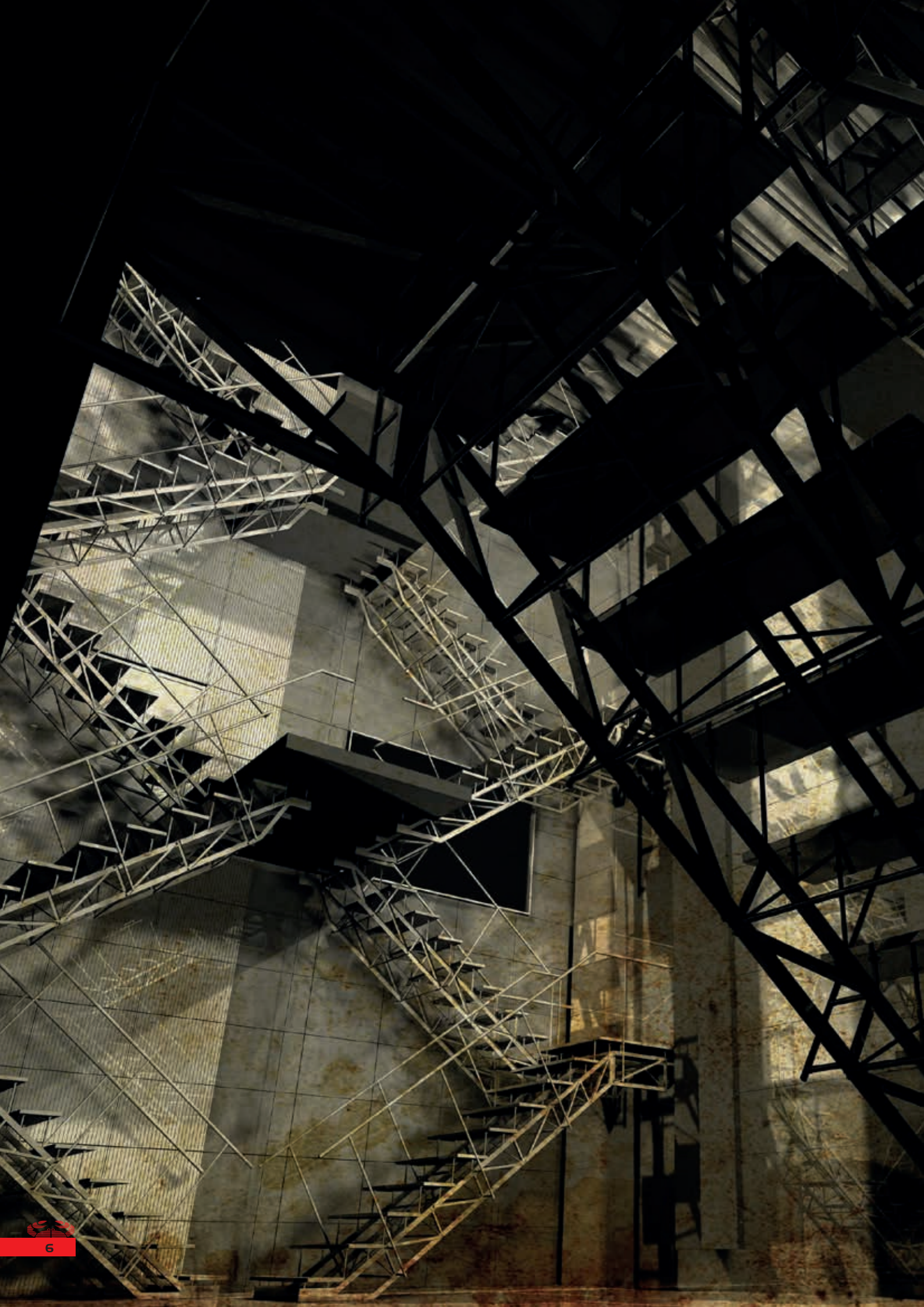



1		TACOS Plugs	Pàg. 9
2		BRIDAS DE NYLON Nylon Cable Ties	Pàg. 23
3		ABRAZADERAS NYLON Nylon Clamps	Pàg. 31
4		ABRAZADERAS METÁLICAS Metallic Clamps	Pàg. 45
5		SOPORTACIÓN Supports	Pàg. 57
6		ANCLAJES Anchors	Pàg. 61
7		FIJACIONES QUÍMICAS Chemical Fixings	Pàg. 73
8		TORNILLERÍA Y ACCESORIOS Screws & Accessories	Pàg. 85
9		MÁQUINA DE GAS Y ACCESORIOS Gas Nailer & Welding	Pàg. 93
10		BLISTERS Blisters	Pàg. 101
11		ACCESORIOS Accessories	Pàg. 109
12		INFORMACIÓN Information	Pàg. 119

TACOS

BRIDAS

ABRAZ. NYLON

ABRAZ. METAL

SOPORTACIÓN

ANCLAJES

QUÍMICO

TORNILLERÍA

GAS

BLISTERS

ACCESORIOS



TACOS

Plugs

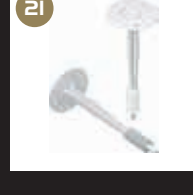
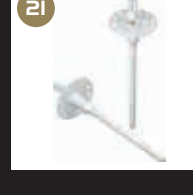
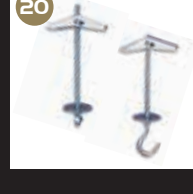
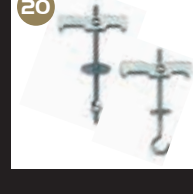
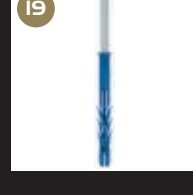
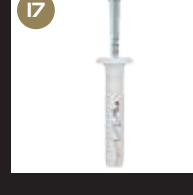
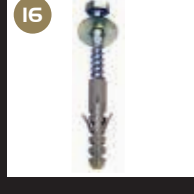
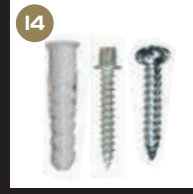
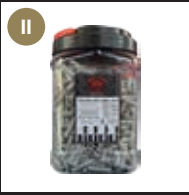



DISCOS
MADINA DE GAL
SERRADORES DE BICO
SISTEMAS DE FIJACIÓN





LAPAFIL

BIDONES DE TACOS NYLON LP4



TACOS DE NYLON LP4 EN BIDÓN

Nylon Plugs LP4 in Plastic Jar

COD	 mm.		 x 	€ x BOTE
3915	5X25	1.500	6	39,00
3916	6x30	1.000	6	28,00
3918	8x40	500	6	24,50
3920	10x50	250	6	23,50



TACOS DE NYLON EN CAJA

Nylon Plugs in Box

COD	mm.	Unid. x	Unid. x	€ x 100
3200	4X20	100	12.000	1,90
3201	5X25	100	12.000	1,95
3202	6x30	100	12.000	2,43
3207	7x30	100	12.000	3,25
3203	8x40	100	6.000	5,15
3204	10x50	50	3.000	9,75
3205	12x60	25	1.500	15,80
3206	14x70	20	1.200	25,25
3208	16x80	10	600	49,00
3209	20x90	7	420	105,00



TACOS HD EN CAJA

HD Plugs in Box

COD	mm.	Unid. x	Unid. x	€ x 100
3861	5X25	100	12.000	1,80
3862	6x30	100	12.000	1,95
3864	8x40	100	6.000	2,95
3865	10x50	50	3.000	5,50



TACOS DE NYLON + TORNILLOS

Nylon Plugs with Collar + Screws

COD	mm.	mm.	mm.	Unid. x	Unid. x	€ x 100
12510	6X30	5X25	10	100	3.000	12,17
12511	6X30	5X30	10	100	3.000	15,00
12513	6X30	4,5x35	8	100	3.000	15,25
12512	6X30	M-6x30	M-6	100	3.000	11,89



TACOS DE NYLON LP4

Nylon Plugs Lp4

COD	mm.	Unid.	Unid.	€ x 100
3905	5x25	100	12.000	2,90
3906	6x30	100	12.000	3,10
3908	8X40	100	6.000	5,10
3910	10x50	50	3.000	9,60

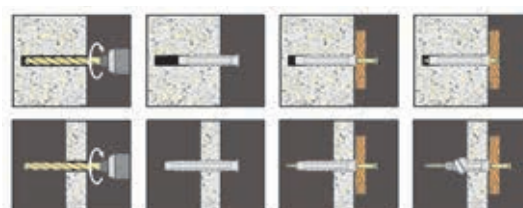

TACO LP4 CON ALCAYATA EN BOLSA

Plastic Plugs with angle screws in bag

COD	mm.	mm.	Unid.		€
3960	5X25	2,7X35	12	50	275,00
3961	6X20	3X40	12	50	275,00
3962	8x40	4,5X55	6	50	275,00



TACO LP4 Ø6 CON TORNILLO ABRAZADERA

Lp4 Plugs Ø6 with screw

COD	mm.	mm.	Unid.	Unid.	€ x 100
12530	6X30	4,5X35	100	1.200	15,25



TACO LP4 Ø6 CON TORNILLO POZIDRIV

Lp4 Plugs Ø6 with M6 screw

COD	mm.	mm.	Unid.	Unid.	€ x 100
12531	6X30	4,5X35	100	1.200	15,00
12532	6X30	4,5X40	100	1.200	15,50

PLUGS



TACOS DE COLLARÍN EN CAJA

Plugs with Collar in Box

COD	mm.	Unid. x	Unid. x	€ x 100
3000	5X25	100	12.000	1,95
3001	6x30	100	12.000	2,28
3002	8x40	100	6.000	4,51
3003	10x50	50	3000	8,49



TACOS DE COLLARÍN + TORNILLOS

Plugs with Collar + Screws

COD	mm.	mm.	mm.	Unid. x	Unid. x	€ x 100
12559	6X30	5X25	10	100	3.000	12,00
12560	6X30	5X30	10	100	3.000	15,00
12562	6X30	4,5x35	8	100	3.000	15,10
12561	6X30	M-6x30	M-6	100	3.000	11,66



TACOS UNIVERSALES CON COLLARÍN

Universal Plugs with Collar

COD RAL 7035	mm.	mm.	Unid. x	Unid. x	€ x 100
3426	6	37	100	6.000	4,63
3428	8	51	50	1.500	8,67
3430	10	60	50	1.500	13,72



TACO KS





KS Universal Plugs

COD RAL 7035	mm.	mm.	Unid. x	Unid. x	€ x 100
KS-06	6	40	200	3.600	5,50
KS-08	8	50	200	3.600	7,95
KS-10	10	60	100	1.800	12,90



TACOS DE PLÁSTICO





Plastic Plugs

COD	 mm.	Unid. 	Unid. 	Unid. 	€ x 100
3400	5X20	25	1.000	20.000	1,58
3401	6X20	25	1.000	15.000	1,84
3402	7x22	25	1.000	12.000	2,21
3403	8x25	25	1.000	12.000	2,58
3404	9x30	25	1.000	10.000	3,10
3406	10x40	25	1.000	6.000	4,73
3407	12x42	25	500	4.000	8,30



TACOS PH (PARED HUECA)

PH Plugs

COD		 mm.	 mm.	Unid. 	Unid. 	€ x 100
3410	10	38	4x50	100	1.200	10,00
3411	10	47	4x60	100	600	11,00
3412	8	35	3,5x40	100	1.200	9,00
3413	8	42	3,5x50	100	1.200	10,00

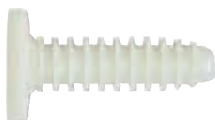

TACOS CANALETA

Channel Plug

COD RAL 9003		mm.	Unid. 	Unid. 	€ x 100
14748	6	30	100	6.000	10,50



TACOS MINI CANAL

Mini Channel Plug

COD RAL 9003		mm.	Unid. 	Unid. 	€ x 100
14745	5	22	200	12.000	10,50



FIJACIONES CALENTADOR CON TORNILLO

Fixation for Heater with Screw

COD	↑mm.	Unid.		€
7100	8x60	2	100	189,00
7101	8x70	2	100	205,00
7102	10x80	2	100	365,00



FIJACIONES CALENTADOR DE ALCAYATA

Fixation for Heater with Angle Hook

COD	↑mm.	Unid.		€
7105	8x65	2	200	162,00
7106	10x75	2	200	190,00



FIJACIONES PARA LAVABO

Fixings for Washbasins

COD	1.	2.		↑mm.	Unid.		€
7091	•		12	10x120	2	100	213,39
7092		•	10	8x100	2	150	165,20
7093		•	12	10x110	2	100	213,39



FIJACIONES PARA WC

Fixings for WC

	COD		↑mm.	Unid.		€
1.	7094	8	5x50	2	250	270,00
1.	7095	8	5x50	2	250	115,00
2.	7096	8	6x40	2	200	291,67



TACO CLAVO MÉTRICO

Plugs with Metric Screw

COD			Unid.	Unid.	€ x 100
12520	6	35	100	3000	26,50



TACO GOLPE CON CABEZA CILÍNDRICA

Cylindrical Head Hammer Screw Nail



COD		 mm.		Unid. 	Unid. 	€ x 100
FX-05C025	5	25	PZ2	200	4.800	4,90
FX-05C030	5	30	PZ2	200	4.800	4,95
FX-05C035	5	35	PZ2	200	4.800	5,40
FX-05C040	5	40	PZ2	200	4.800	5,50
FX-06C035	6	35	PZ2	100	2.400	5,90
FX-06C040	6	40	PZ2	100	1.600	6,10
FX-06C045	6	45	PZ2	100	1.600	6,60
FX-06C060	6	60	PZ2	100	1.200	8,50
FX-06C080	6	80	PZ2	100	1.200	10,95
FX-08C045	8	45	PZ2	100	1.200	12,50
FX-08C060	8	60	PZ2	100	1.200	13,50
FX-08C080	8	80	PZ2	50	600	18,50
FX-08C100	8	100	PZ2	50	600	24,70
FX-08C120	8	120	PZ2	50	600	28,00
FX-08C140	8	140	PZ2	50	600	32,00
FX-08C160	8	160	PZ2	50	600	33,00

TACO GOLPE CON CABEZA CÓNICA

Countersunk Head Hammer Screw Nail



COD		 mm.		Unid. 	Unid. 	€ x 100
FX-05L025	5	25	PZ2	200	4.800	4,70
FX-05L030	5	30	PZ2	200	4.800	4,95
FX-05L035	5	35	PZ2	200	4.800	5,40
FX-05L040	5	40	PZ2	200	4.800	5,60
FX-06L035	6	35	PZ2	100	2.400	6,00
FX-06L040	6	40	PZ2	100	1.600	6,10
FX-06L050	6	50	PZ2	100	1.600	8,00
FX-06L060	6	60	PZ2	100	1.200	9,10
FX-06L080	6	80	PZ2	100	1.200	12,00
FX-08L045	8	45	PZ2	100	1.200	12,25
FX-08L060	8	60	PZ2	100	1.200	13,50
FX-08L080	8	80	PZ2	50	600	18,00
FX-08L100	8	100	PZ2	50	600	23,80
FX-08L120	8	120	PZ2	50	600	25,80
FX-08L140	8	140	PZ2	50	600	30,75
FX-08L160	8	160	PZ2	50	600	35,00

TACO GOLPE CON CABEZA MUSHROOM

Mushroom Head Hammer Screw Nail



COD		 mm.		Unid. 	Unid. 	€ x 100
FX-06K040	6	40	PZ2	200	2.400	6,10



ANCLAJE METÁLICO PARA PLADUR

Metal Cavity Fixings

COD				Unid. 	Unid. 	€ x 100
CON TORNILLO / With Screw						
SM-04020	8	4×25	3-5	100	1.800	20,02
SM-04032	8	4×40	4-10	100	1.800	21,78
SM-04046	8	4×54	15-21	100	1.800	25,30
SM-04059	8	4×66	34-38	100	1.800	33,28
SM-05037	11	5×46	6-12	100	1.800	33,25
SM-05052	11	5×61	6-16	100	1.800	37,62
SM-05065	11	5×73	16-30	100	1.200	43,56
SM-06037	13	6×46	8-12	100	1.200	45,00
SM-06052	13	6×61	8-18	100	1.200	47,19
SM-06065	13	6×73	16-30	50	600	52,42
SM-06080	13	6×90	32-45	50	600	95,00
SM-08080	13	8×90	32-45	50	600	101,50
CON ALCAYATA / With Angle Hook						
SM-04032K	8	M4×55	4-10	100	1.800	45,00
CON GANCHO / With Round Hook						
SM-04032S	8	M4×70	4-10	100	1.800	45,00

MÁQUINA PARA ANCLAJE METÁLICO DE PLADUR

Metal Cavity Fixings Setting Tool

COD		Unid. 	€ x Unid.
AT-88 RAWL	Professional	1	25,000

TACOS PLADUR AUTOTALADRANTES

Plasterboard Fixings

COD				Unid. 	Unid. 	€ x 100
DRA-01	Nylon	14	22	100	1.800	9,750
DRA-02	Zamak	14	28	100	1.800	41,000
DRA-03	Zamak	14	32	100	1.800	46,000
DRA-01PLUS	Nylon	14	22	100	1.800	20,000
DRA-02PLUS	Zamak	14	28	100	1.800	55,000
DRA-03PLUS	Zamak	14	32	100	1.800	60,000



TACO FFI PARA MARCOS AVELLANADO

FFI Frame Fixing

COD			Unid.	€ x 100
R-FF1-N-10L080	10x80	7x89	50	65,00
R-FF1-N-10L100	10x100	7x109	25	77,00
R-FF1-N-10L120	10x120	7x129	25	87,00
R-FF1-N-10L140	10x140	7x149	25	120,00
R-FF1-N-10L160	10x160	7x169	25	140,00



TACOS FFI PARA MARCOS HEXAGONAL

FFI Frame Fixing with Hexagonal Screw

COD			Unid.	€ x 100
R-FF1-N-10K080	10x80	7x89	50	81,00
R-FF1-N-10K100	10x100	7x109	25	88,00
R-FF1-N-10K120	10x120	7x129	25	97,00
R-FF1-N-10K140	10x140	7x149	25	108,00
R-FF1-N-10K160	10x160	7x169	25	130,00



TACO KDS PARA MARCOS POZIDRIV

KDS Frame Fixing

COD			Unid.	€ x 100
KDS-08100	8x100	4,8x105	50	38,50
KDS-08120	8x120	4,8x125	50	41,00
KDS-08140	8x140	4,8x145	50	46,00
KDS-10080	10x80	6,8x85	50	42,00
KDS-10100	10x100	6,8x105	25	50,50
KDS-10120	10x120	6,8x125	25	53,00
KDS-10140	10x140	6,8x145	25	67,50
KDS-10160	10x160	6,8x165	25	84,00
KDS-10200	10x200	6,8x205	25	117,00
KDS-10240	10x240	6,8x245	25	174,00



TACOS KD PARA MARCOS HEXAGONAL

Hexagonal KD Frame Fixing

COD			Unid.	€ x 100
KD-10080	10x80	6,8x85	50	43,00
KD-10100	10x100	6,8x105	25	53,00
KD-10120	10x120	6,8x125	25	58,50
KD-10140	10x140	6,8x145	25	84,00
KD-10160	10x160	6,8x165	25	96,00
KD-10200	10x200	6,8x205	25	125,00
KD-10240	10x240	6,8x245	25	175,00
KD-16140	16x140	12x150	25	200,00
KD-16160	16x160	12x170	25	300,00
KD-16200	16x200	12x210	20	360,00
KD-16240	16x240	12x250	20	700,00

A*. Hormigón, Ladrillo Macizo Piedra, Gero /Concrete
B*. Ladrillo Hueco, bloque de Hormigón/Solid Brick

K - Profundidad mínima de taladro/Min.depth.
D - Diámetro del Taco/Plug diameter.
L - Longitud del Taco/Plug Length.
U - Espesor Máximo. A Fijar/Max.fixture thickness.

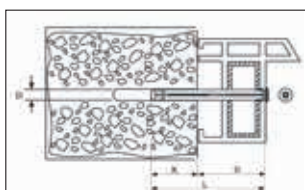

ANCLAJE METÁLICO PARA MARCOS





Metal Frame Anchors

COD			H mm		U mm		Unid.	€ x 100
			A*	B*	A*	B*		
15580	M6x72	10	30	60	40	10	100	59,20
15581	M6x92	10	30	60	60	30	100	61,95
15582	M6x112	10	30	60	80	50	100	66,08
15583	M6x132	10	30	60	100	70	100	72,97
15584	M6x152	10	30	60	120	90	100	81,23
15585	M6x182	10	30	60	150	120	100	92,00
15586	M6x202	10	30	60	170	140	100	98,00



BASCULANTES





Gravity Toggles

COD				Unid. 	Unid. 	€ x 100
8000		•	M-4	100	400	40,00
8001		•	M-5	100	400	49,00
8002		•	M-6	50	200	70,00
8200	•		M-4	100	400	42,00
8201	•		M-5	100	400	47,00
8202	•		M-6	50	200	70,00



GANCHOS Y ESPIGAS DE ARPÓN



Harpoon and Spike Toggles

COD				Unid. 	Unid. 	€ x 100
8400	•		M-4	100	400	44,34
8410	•		M-5	50	300	55,68
8420	•		M-6	50	300	71,63
8430		•	M-4	100	400	48,76
8440		•	M-5	50	300	70,07
8450		•	M-6	50	300	94,77



BASCULANTES SUELTOS



Toggles

COD		Unid. 	Unid. 	€ x 100
8040	M-4	100	3.000	22,00
8041	M-5	100	1.200	28,35
8042	M-6	100	600	38,00
8043	M-8	100	600	55,50

KWL ARANDELAS PARA TACO ISO

KWL Insulation Holding Flange



COD	 mm.	Unid. 	€ x 100
Poliamida PA 6, reforzada con fibra de vidrio / Polyamide PA 6			
KWL-90	90	200	37,00
KWL-110	110	200	54,00
KWL-140	140	200	81,00
Resistente al impacto, copolímero / Copolymer			
KWL-90-PP	90	250	29,00
KWL-140-PP	140	200	49,00





ETA-07/0336

ETA-07/0221

ETA-07/0291

TACO ISO KI-HO CON CLAVO DE NYLON



KI-HO Insulation Fixings with Nylon Nail

COD	 mm.	 max mm.	Unid. 	€ x 100
KI-070	70	40	250	20,00
KI-090	90	60	250	22,25
KI-120	120	90	250	24,45
KI-140	140	110	250	29,50
KI-160	160	130	250	35,00
KI-180	180	150	250	38,00
KI-200	200	170	250	49,00
KI-220	220	190	250	59,00



TACO ISO TFIX-8M CON CLAVO DE ACERO



TFIX-8M Insulation Fixings with Steel Nail

COD	 mm.	 max mm.	Unid. 	€ x 100
R-TFIX-8M-095	95	60	200	71,00
R-TFIX-8M-115	115	80	200	73,00
R-TFIX-8M-135	135	100	200	78,00
R-TFIX-8M-155	155	120	200	83,00
R-TFIX-8M-175	175	140	200	90,00
R-TFIX-8M-195	195	160	200	98,00
R-TFIX-8M-215	215	180	100	108,00
R-TFIX-8M-235	235	200	100	121,00
R-TFIX-8M-255	255	150	100	132,00
R-TFIX-8M-275	275	170	100	148,00
R-TFIX-8M-295	295	190	100	163,00



TACO GOLPE PARA AISLAMIENTO

KIK Insulation Supports

COD	 mm.	 max mm.	Unid. 	€ x 100
KIK-070	70	35	400	10,00
KIK-090	90	35	500	11,25



ARANDELA PARA AISLAMIENTO CON TAPÓN

KC Insulation Flange with Masking Cap

COD	 mm.			Unid. 	€ x 100
KC	60	5,5	Sin tornillo	200	20,00



2

BRIDAS DE NYLON

Nylon Cable Ties

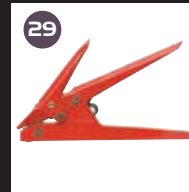
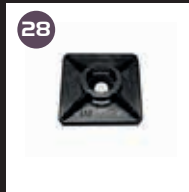
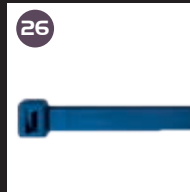



SISTEMAS DE FIJACIÓN

ABRAZADERAS DE BILÓN TRIZO

CAPAF

TACOS

DE N...



BRIDAS DE NYLON 6.6

Nylon 6.6 Cable Ties

COD	COD	↑mm.	∅ max. mm.	↓ Kg.	Unid. x	Unid.	€ x 100
20102	21102	100x2,5	14	8	100	50.000	1,08
20103	21103	130x2,5	30	8	100	25.000	2,17
20105	21105	200x2,5	52,5	8	100	25.000	2,84
20106	21106	140x3,6	33	18	100	25.000	2,69
20107	21107	200x3,6	52,5	18	100	20.000	3,74
20108	21108	300x3,6	84	18	100	10.000	5,53
20110	21110	160x4,6	36,6	22,44	100	10.000	4,23
20113	21113	200x4,8	49,5	22,44	100	10.000	4,56
20114	21114	250x4,8	65	22,44	100	10.000	6,73
20115	21115	300x4,8	81	22,44	100	10.000	7,32
20116	21116	360x4,8	100	22,44	100	5.000	9,04
20117	21117	430x4,8	122,5	22,44	100	5.000	14,19
20121	21121	300x7,6	82,8	55	100	5.000	15,39
20122	21122	370x7,6	103,5	55	100	2.500	18,46
20124	21124	550x7,6	162,5	55	100	1.000	35,25
20125	21125	780x8,8	235,5	80	100	1.000	57,47
20126	21126	750x7,6	226	55	100	1.000	52,00
20131	21131	1.000x12,4	315	120	100	1000	141,75

BRIDAS DE NYLON 6.6 - COLORES

Nylon 6.6 Coloured Cable Ties

COD		↑mm.	∅ max. mm.	↓ Kg.	Unid. x	Unid.	€ x 100
20213	□	200x4,8	50	22,44	100	10.000	5,10
20215	○	290x4,8	79	22,44	100	7.500	7,88
20230	●	98x2,5	21	8,16	100	35.000	1,46
20231	●	140x3,5	35	18,34	100	20.000	3,05
20232	●	200x3,5	50	18,34	100	15.000	4,31
20233	●	200x4,8	50	22,44	100	10.000	5,10
20234	●	290x4,8	79	22,44	100	7.500	7,88
20240	●	98x2,5	21	8,16	100	35.000	1,46
20241	●	140x3,5	35	18,34	100	20.000	3,05
20242	●	200x3,5	50	18,34	100	15.000	4,31
20243	●	200x4,8	50	22,44	100	10.000	5,10
20244	●	290x4,8	79	22,44	100	7.500	7,88
20250	●	98x2,5	21	8,16	100	35.000	1,46
20251	●	140x3,5	35	18,34	100	20.000	3,05
20252	●	200x3,5	50	18,34	100	15.000	4,31
20253	●	200x4,8	50	22,44	100	10.000	5,10
20254	●	290x4,8	79	22,44	100	7.500	7,88
20260	●	98x2,5	21	8,16	100	35.000	1,46
20261	●	140x3,5	35	18,34	100	20.000	3,05
20262	●	200x3,5	50	18,34	100	15.000	4,31
20263	●	200x4,8	50	22,44	100	10.000	5,10
20264	●	290x4,8	79	22,44	100	7.500	7,88



BRIDAS NYLON



DETECTABLES



BRIDAS NYLON DETECTABLES

Detectable Nylon Cable Ties

COD	↑mm.	∅ max. mm.	↓Kg	Unid./x	Unid. caja	€ x 100
20160	2,5 x 100	14	8	100	50.000	3,00
20161	130 x 2,5	30	8	100	20.000	7,00
20162	3,6 x 200	52,5	18	100	20.000	9,00
20163	4,8 x 200	49,5	22,44	100	10.000	11,00
20164	4,8 x 300	81	22,44	100	10.000	17,00
20165	4,8 x 370	100	22,44	100	5.000	24,00
20166	7,6 x 370	103,5	55	100	2.500	44,00

ESTE PRODUCTO HA SIDO ANALIZADO SEGÚN LA NORMATIVA EN 62275 : 2015 - BRIDAS DE NYLON PARA INSTALACIONES ELÉCTRICAS

NOVEDAD

PARA INDUSTRIA ALIMENTARIA

APLICACIÓN:

Para la sujeción en todo tipo de instalaciones de electricidad, neumática, aire acondicionado, etc. en instalaciones alimentarias.

Sus bordes son redondeados para una mayor seguridad en instalaciones.

CARACTERÍSTICAS:

Autoextinguibilidad UL94 V2 según UL 62275:2015.

Cumple normativa RoHS directiva (EU) 2016/863 que modifica el anexo II de la Directiva 2011/65/UE.

Cumple Normativa REACH.

MATERIAL:

Fabricado en Poliamida 6.6 (Nylon) + compuestos detectables.
Color azul.





1. Ø8 mm.

3. Ø6 mm.



2. Ø8 mm.



TACOS DE PRESIÓN PARA BRIDAS

Pressure Plugs

	COD RAL 9005	COD RAL 7035	COD RAL 9003	↑mm.	↔	Unid./x	Unid. x100	€ x 100
1.	21160	21162	21163	10x37	8	100	5.000	7,10
2.	21161	-	-	10x37	8	100	4.500	15,00
3.	21165	21166	21167	8x34	6	100	5.000	6,80



BRIDAS DE NYLON 6.6 REUTILIZABLES

Reusable Nylon Cable Ties

COD	COD	↑mm.	∅ max. mm.	↕ Kg.	Unid./x	Unid. x100	€ x 100
20300	21300	200x7,5	50	22,44	100	7.500	20,50
20301	21301	250x7,5	65	22,44	100	5.000	24,00
20302	21302	350x7,5	100	22,44	100	4.500	32,00



SOPORTES BRIDAS

Supports for Cable Ties

	COD	COD	max.	Unid. x	Unid.	€ x 100
1.	20158	21158	4,8	100	10.000	7,60
2.	20159	21159	9	100	5.000	12,70

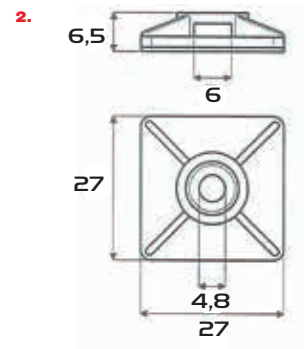
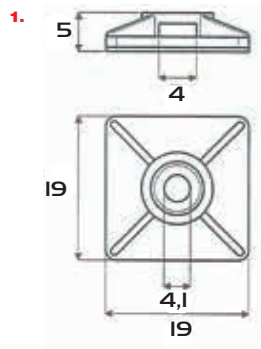
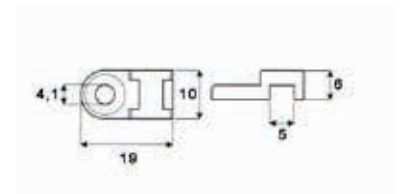
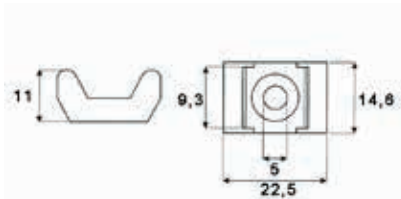

BASES BRIDAS

Bases for Cable Ties

	COD	COD			max.	Unid. x	Unid.	€ x 100
1.	20154	21154	•	•	3,6	100	15.000	14,12
2.	20155	21155	•	•	4,8	100	6.000	20,39
1.	20156	21156	•	•	3,6	100	15.000	9,79
2.	20157	21157	•	•	4,8	100	6.000	15,50

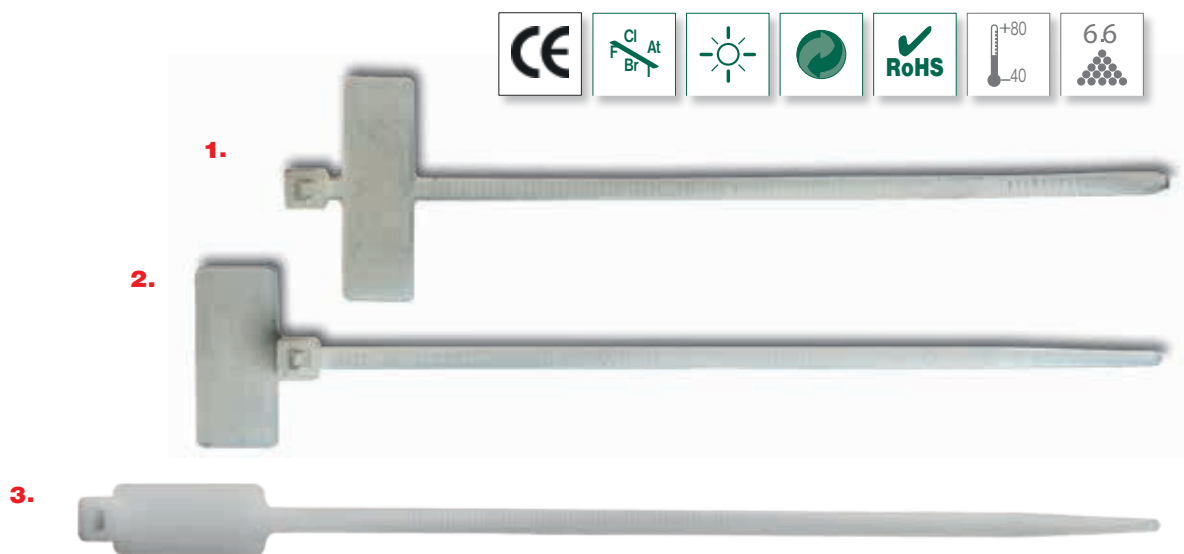

BRIDAS DE NYLON CON SEÑALIZADOR

Cable Ties with Identification

	COD	mm.	max. mm.	Kg.	Unid./x	Unid.	€ x 100
1.	20132	2,5X100	22	8	100	10.000	7,47
2.	20133	2,5X110	22,60	8	100	10.000	8,21
NOVEDAD 3.	20135	4,8X190	50,90	22,44	100	5.000	10,00
NOVEDAD 3.	20137	4,8X370	106,70	22,44	100	5.000	16,00



PISTOLA PARA BRIDAS

Gun for Cable Ties

	COD	mm.	max.	Unid. /x	Unid.	€ x Unid.
1.	20139	165	4,8	1	10	37,50
2.	20140	190	9	1	15	39,50



FUNDA ESPIRAL

Spiral Binding

	COD	COD	max. mm.	Mts./x	Mts.	€ x 100
	20143	21143	3-15	50	2.000	45,25
	20144	21144	4-20	25	1.000	62,72
	20145	21145	7-40	25	500	73,10
	20146	21146	9-50	25	350	84,00
	20147	21147	11-70	25	250	116,78
	20148	21148	13-80	20	200	130,67
	20149	21149	18-120	25	100	297,92



3

ABRAZADERAS NYLON

Nylon Clamps





CON PRE-ROSCA M-6

Pre-threaded M-6

COD RAL 7035	COD RAL 9005	∅ mm.	PG	∅"	Unid. x	Unid. x	€ x 100
19012	19512	12	-	1/2	100	600	19,12
19015	19515	15	9	9/16	100	600	20,97
19016	19516	16	-	5/8	100	600	21,42
19018	19518	18	11	11/16	100	400	23,98
19020	19520	20	13	13/16	100	400	25,48
19022	19522	22	16	7/8	100	400	26,19
19025	19525	25	-	1	100	400	28,59
19028	19528	28	21	1 1/8	50	300	35,52
19032	19532	32	-	1 1/4	25	150	40,99
19035	19535	35	-	1 3/8	25	150	48,42
19037	19537	37	29	1 7/16	25	150	50,98
19040	19540	40	-	1 9/16	25	150	56,33
19042	19542	42	-	1 5/8	25	150	55,34
19047	19547	47	36	1 7/8	25	150	59,89
19050	19550	50	-	1 15/16	25	100	76,61



LA MÁXIMA SEGURIDAD EN NYLON

MAXIMUM SAFETY IN NYLON



CON CASQUILLO M-6

With M-6 Nut

COD RAL 7035	COD RAL 9005	∅ mm.	PG	∅"	Unid. x	Unid. x	€ x 100
19312	19812	12	-	1/2	100	600	35,53
19315	19815	15	9	9/16	100	600	38,68
19316	19816	16	-	5/8	100	600	39,12
19318	19818	18	11	11/16	100	400	41,68
19320	19820	20	13	13/16	100	400	43,18
19322	19822	22	16	7/8	100	400	43,90
19325	19825	25	-	1	100	400	49,56
19328	19828	28	21	1 1/8	50	300	53,23
19332	19832	32	-	1 1/4	25	150	58,69
19335	19835	35	-	1 3/8	25	150	66,12
19337	19837	37	29	1 7/16	25	150	69,03
19340	19840	40	-	1 9/16	25	150	74,03
19342	19842	42	-	1 5/8	25	150	73,04
19347	19847	47	36	1 7/8	25	150	77,59
19350	19850	50	-	1 15/16	25	100	95,86



ABRAZ. NYLON



MÁXIMA RETENCIÓN
MAXIMUM HOLDING



HASTA 25 mm. | TO 25 mm.



ABRAZADERAS ABRAFIX

Abrafix Clamps

COD RAL 9003	∅ mm.	Unid. K	Unid. X	€ x 100
14112	12	100	1.200	27,00
14115	14-15	100	600	29,80
14118	16-18	100	600	36,50
14122	20-22	100	600	38,30
14125	25	100	600	41,00
14128	28	50	300	49,00



ABRAZADERAS BIFIX

Bifix Clamps

COD RAL 9003	∅ mm.	Unid. K	Unid. X	€ x 100
14212	12	50	300	49,30
14215	14-15	50	300	52,75
14218	16-18	50	300	65,70
14222	20-22	50	200	71,00
14228	28	25	150	96,00



ABRAZ. LAPACLIP CON PRE-ROSCA M-6

Pre-threaded M-6 Lapaclip Clamp

COD RAL 7035	COD RAL 9005	∅ mm.	PG	∅"	Unid. K	Unid. X	€ x 100
18010	18510	10	-	3/8	100	1.200	15,27
18012	18512	12	-	1/2	100	1.200	15,27
18015	18515	15-16	9	9/16	100	600	17,92
18018	18518	18	11	11/16	100	600	20,16
18020	18520	20-22	13-16	13/16	100	600	23,52
18025	18525	25	-	1	100	600	29,12
18028	18528	28	21	1 1/8	50	300	32,48
18032	18532	32	-	1 1/4	25	150	41,50
18037	18537	35-37	29	1 3/8	25	150	47,04
18040	18540	40	-	1 9/16	25	150	55,00
18047	18547	47	36	1 7/8	25	150	89,60



NYLON CLAMPS



ABRAZADERAS LPH

LPH Clamps

COD RAL 7035	COD RAL 9003	∅ mm.	Unid. 	Unid. 	€ x 100
25531	25511	15-18	100	600	22,00
25532	25512	20-25	50	300	32,00
25533	25513	25-32	50	200	36,00



ABRAZADERA FIX-EXPRESS

Fix-Express Clamps

COD RAL 7035	∅ mm.		Unid. 	Unid. 	€ x 100
25600	10-12	550	100	600	28,00
25601	14-16	900	100	400	32,67
25602	16,5-20	700	100	400	36,17
25603	20-23	800	100	400	42,00
25604	25-29	800	50	200	45,50
25605	32-35	1.000	50	200	58,34
25606	40-45	900	25	150	79,34
25607	48-55	800	25	100	110,84
25608	58,5-65	1.000	20	80	130,67



ABRAZADERAS LPX

Lpx Clamps

COD RAL 7035	∅ mm.	Unid. 	Unid. 	€ x 100
25501	15-18	100	400	33,00
25502	20-25	50	200	40,00
25503	25-32	50	200	48,00



BASE BRIDA DISPARO

Tie Bases

COD RAL 7035	COD RAL 9005		Unid. 	Unid. 	€ x 100
25520	25521	10 mm.	100	2.400	9,91





SEPARADOR

Separator

COD RAL 7035	COD RAL 9005	Unid.	Unid.	€ x 100
23000	23001	100	3.000	55,07



ABRAZADERAS PRATIC SIMPLES

Single Pratic Clamps

COD RAL 7035	∅ mm.	∅"	Unid.	Unid.	€ x 100
14512	12	1/2	100	600	35,28
14514	14	9/16	100	600	44,10
14516	16	5/8	100	600	48,00
14518	18	11/16	100	400	64,00
14520	20	13/16	100	400	74,34
14522	22	7/8	100	400	78,12
14525	25	1	50	200	140,00
14528	28	1 1/8	50	200	144,90



ABRAZADERAS PRATIC DOBLES

Double Pratic Clamps

COD RAL 7035	∅ mm.	∅"	Unid.	Unid.	€ x 100
14612	12	1/2	100	400	61,74
14614	14	9/16	100	400	65,52
14615	15	9	100	400	67,00
14616	16	5/8	100	400	68,04
14618	18	11/16	50	200	100,80
14620	20	13/16	50	200	124,74
14622	22	7/8	50	200	127,26
14628	28	1 1/8	25	100	176,40

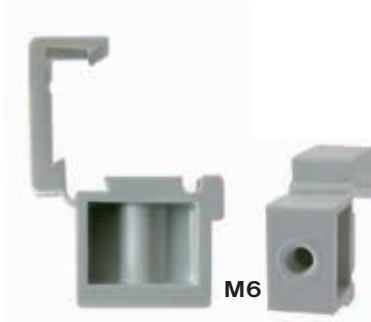

ABRAZADERAS FIBRA ÓPTICA

Optical Fiber Clamp

COD RAL 7035	∅ mm.	Unid.	Unid.	€ x 100
19974	4	100	400	59,26

Otras medidas consultar | Other sizes please contact us

MULTI RING

ABRAZ. NYLON



FIJACIÓN DE TUBOS RÍGIDOS Y COARRUGADOS

MULTI-DIÁMETRO: UN SOLO PRODUCTO PARA DIFERENTES DIÁMETROS.

SIMPLE Y RÁPIDO, PARA PARED, TECHOS Y SUELO.



ÁREA DE IMPACTO REFORZADA.

100% NYLON - POLIAMIDA 6.

NOVEDAD

ABRAZADERAS MULTI-RING DOBLE DE NYLON GRIS

Double Multi-Ring Clamps grey

COD	∅ mm.		Unid. 	€ x 100
14760	16-20	8	50	64,00
14761	22-26	10	40	86,00





ABRAZ. NYLON





ABRAZADERAS MULTI-RING DOBLE DE NYLON BLANCO

Double Multi-Ring Clamps white

COD	∅ mm.		Unid. 	€ x 100
14770	16-20	8	50	64,00
14771	22-26	10	40	86,00

ABRAZADERAS MULTI-RING CUADRUPLE DE NYLON GRIS



Quadruple Multi-Ring Clamps Grey

COD	∅ mm.		Unid. 	€ x 100
14765	16-20	8	25	102,00
14766	22-26	10	20	135,00



ABRAZADERAS MULTI-RING CUADRUPLE DE NYLON BLANCO

Quadruple Multi-Ring Clamps white

COD	∅ mm.		Unid. 	€ x 100
14775	16-20	8	25	102,00
14776	22-26	10	20	135,00



ABRAZADERAS NYLON FIX-RING

Fix-Ring Clamps

COD RAL 7035	∅ mm.	Unid. 	Unid. 	€ x 100
14710	14	100	600	29,00
14711	16	100	600	30,00
14712	18	100	400	31,00
14713	20	100	400	32,00
14714	22	100	400	33,00
14715	25	100	400	34,00
14716	28	50	300	42,00
14717	32	50	200	52,00



ABRAZADERAS FIX-RING DOBLES

Double Fix-Ring Clamps

COD RAL 7035	∅ mm.	Unid. 	Unid. 	€ x 100
14720	16	100	400	36,00
14721	18	50	300	40,00
14722	20	50	300	41,00
14723	22	50	200	44,00
14724	25	50	200	48,00
14725	28	50	200	61,00



ABRAZADERAS FIX-RING CUADRUPLE

Quadruple Fix-Ring Clamps

COD RAL 7035	∅ mm.	Unid. 	Unid. 	€ x 100
14730	20	25	150	80,00
14731	25	25	100	101,00



ABRAZADERAS FIX-RING CLIM

Fix-Ring Clim Clamps

COD RAL 7035	∅ mm.	Unid. 	Unid. 	€ x 100
14735	32-25	25	150	84,00



ABRAZADERAS FAST-RING

Fast-Ring Clamps

COD RAL 7035	∅ mm.	Unid. 	Unid. 	€ x 100
14740	16	100	600	35,59
14741	20	100	600	37,80

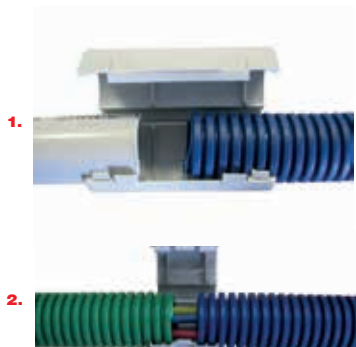

ABRAZADERAS CONNECT RING

Connect Ring Clamps

	COD RAL 7035	∅ mm.	Unid. 	Unid. 	€ x 100
1.	14750	16	50	300	46,67
1.	14751	20	50	200	49,59
1.	14752	25	50	50	53,09
1.	14753	32	50	50	69,54
2.	14754	16	100	600	35,00
2.	14755	20	100	600	36,00

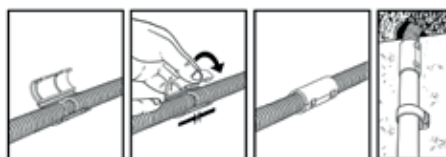

ABRAZADERAS BRIDAFIX

Bridafix Clamps

	COD RAL 7035	COD RAL 9005	∅ mm.	Unid. 	Unid. 	€ x 100
	21170	21175	16-32	100	1.200	41,25
	21171	21176	40-63	100	600	69,54
	21169	-	8	100	5.000	22,35



ABRAZADERAS DOBLE PATA

Double Foot Clamps

	COD RAL 7035	COD RAL 9005	∅ mm.	PG	Unid. 	Unid. 	€ x 100
	4000	4100	14	9	100	1.200	12,88
	4001	4101	18	11	100	600	15,80
	4002	4102	20	13	100	600	17,06
	4003	4103	22	16	100	600	18,44
	4004	4104	28	21	50	300	24,64
	4005	4105	37	29	25	300	30,90
	4006	4106	47	36	25	150	39,01





ABRAZADERAS LAPAFIX

Lapafix Clamps

COD RAL 7035	COD RAL 9006	∅ mm.	Unid. K	Unid. K	€ x 100
25015	25315	15-25	100	400	26,00
25025	25325	25-42	50	200	43,00
25042	25342	42-65	25	100	80,47

PLAQUETAS MÉTRICAS DE LATÓN

Brass Insert



COD	∅ mm.	Unid. K	Unid. K	€ x 100
25006	M-6	100	10.000	5,95
25008	M-8	100	10.000	8,23



CINTA AISLANTE DE PVC 20x19x0,13

Insulating Tapes

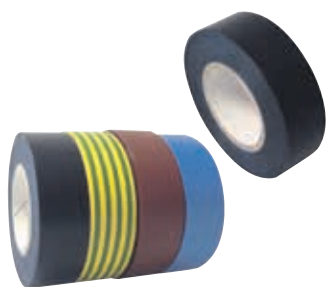

COD	COLOR	Unid. X	Unid. K	€ x 100
2701-N	●	5	100	180,00
2701-A	●	5	100	180,00
2701-G	●	5	100	180,00
2701-M	●	5	100	180,00
2701-T	●	5	100	180,00

Otros colores consultar/ Contact us for other colors

REGLETAS DE CONEXIÓN

Connecting Strips



COD	COD	mm ²	Unid. K	Unid. K	€ x 100
2800	2810	4	10	100	100,00
2801	2811	6	10	100	113,00
2802	2812	10	10	100	200,00
2803	2813	16	10	100	331,00
2804	2814	25	10	100	455,00
2805	2815	35	10	100	700,00

CON CLAVO DE ACERO TEMPLADO
WITH TEMPERED STEEL NAILS



GRAPAS EN CAJA

Clips in Box

COD RAL 9003	COD RAL 7035	COD RAL 9005	Ref.	↑mm.↓	mm. ²	Unid. x	Unid. x	€ x 100
CABLE PLANO Flat cable								
1100	-	-	0	paralelo	2x0,7-2x1	100	30.000	4,07
1101	1000	-	01	4x2	2x0,7	100	30.000	4,29
1102	1001	-	02	paralelo	2x0,7-2x1	100	30.000	4,56
1103	1002	-	03	6x2	2x1-3x0,7	100	30.000	4,61
1104	1003	-	1	6,5x3	2x1	100	20.000	5,49
1105	1004	-	2	7,5x3,5	2x1,5-3x1	100	20.000	5,57
1106	1005	-	3	10x3,5	3x1,5-3x2,5	100	10.000	6,73
CABLE REDONDO Round cable								
COD RAL 9003	COD RAL 7035	COD RAL 9005	Ref.	∅ mm.	mm. ²	Unid. x	Unid. x	€ x 100
1107	1006	1124	4	4	1x1-2x0,5	100	30.000	5,32
1108	1007	1125	5	5	2x0,75	100	20.000	5,44
1109	1008	1126	6	6	2x1	100	20.000	5,77
1110	1009	1127	7	7	2x1-2x1,5	100	10.000	6,30
1111	1010	1128	8	8	2x2,5	100	10.000	6,35
1112	1011	1129	9	9	3x2,5	100	10.000	6,98
1113	1012	1130	10	10	2x4	100	10.000	7,79
1114	1013	1132	12	12	3x6	100	5.400	9,58
1115	1014	1134	14	14	4x6	100	5.400	11,38
1116	1015	1137	17	17	3x10	50	2.700	14,34
1016	(Natural, Naturel, Natur)	TV	TV	7	coaxial	100	10.000	7,52

GRAPAS EN BOLSA

Clips in Bag

COD RAL 9003	COD RAL 7035	COD RAL 9005	Ref.	↑mm.↓	mm. ²	Unid. x	Unid. x	€ x 100
CABLE PLANO Flat cable								
1300	-	-	0	paralelo	2x0,7-2x1	100	27.500	3,37
1301	1200	-	01	4x2	2x0,7	100	27.500	3,98
1302	1201	-	02	paralelo	2x0,7-2x1	100	20.000	4,05
1303	1202	-	03	6x2	2x1-3x0,7	100	17.500	4,10
1304	1203	-	1	6,5x3	2x1	100	10.000	4,69
1305	1204	-	2	7,5x3,5	2x1,5-3x1	100	10.000	4,88
1306	1205	-	3	10x3,5	3x1,5-3x2,5	100	7.500	5,49
CABLE REDONDO Round cable								
COD RAL 9003	COD RAL 7035	COD RAL 9005	Ref.	∅ mm.	mm. ²	Unid. x	Unid. x	€ x 100
1307	1206	1324	4	4	1x1-2x0,5	100	17.500	4,69
1308	1207	1325	5	5	2x0,75	100	12.500	4,75
1309	1208	1326	6	6	2x1	100	10.000	5,09
1310	1209	1327	7	7	2x1-2x1,5	100	7.500	5,47
1311	1210	1328	8	8	2x2,5	100	7.500	5,57
1312	1211	1329	9	9	3x2,5	100	6.000	6,24
1313	1212	1330	10	10	2x4	100	5.000	7,04
1314	1213	1332	12	12	3x6	100	3.000	8,56
1315	1214	1334	14	14	4x6	100	2.500	10,29
1316	1215	1337	17	17	3x10	100	1.500	11,62
1317	(Natural, Naturel, Natur)	TV	TV	7	coaxial	100	4.500	6,37





FUNDA TERMORRETRÁCTIL 2:1 EN BOLSA (1 metro)

Pared Fina

Heat Shrink Tubing 2:1 in Bags (1 m.) | Thin Wall

COD	COLOR	Ø INTERIOR CONTRACCIÓN		ESPESOR	Unid.	€ x 100/mts.
		ANTES	DESPUÉS			
NF201-BN-001.2	NEGRO	1,20	0,60	0,41	50	61,00
NF201-BN-001.6	NEGRO	1,60	0,80	0,43	50	61,00
NF201-BN-002.4	NEGRO	2,40	1,20	0,51	50	67,00
NF201-BN-003.2	NEGRO	3,20	1,60	0,51	50	70,00
NF201-BN-004.8	NEGRO	4,80	2,40	0,51	50	105,00
NF201-BN-006.4	NEGRO	6,40	3,20	0,64	25	124,00
NF201-BN-009.5	NEGRO	9,50	4,70	0,64	25	170,00
NF201-BN-012.7	NEGRO	12,70	6,40	0,64	25	232,00
NF201-BN-019.1	NEGRO	19,10	9,50	0,77	25	448,00
NF201-BN-025.4	NEGRO	25,40	12,70	0,89	15	573,00
NF201-BN-038.1	NEGRO	38,10	19,10	1,02	4	1.122,00
NF201-BN-050.4	NEGRO	50,40	25,20	1,14	3	1.459,00
NF201-BN-076.2	NEGRO	76,20	38,10	1,27	1	3.500,00
NF201-BN-101.6	NEGRO	101,60	50,80	1,40	1	4.500,00
NF201-BR-004.8	ROJO	4,80	2,40	0,51	50	105,00
NF201-BR-006.4	ROJO	6,40	3,20	0,64	25	124,00
NF201-BR-009.5	ROJO	9,50	4,70	0,64	25	170,00
NF201-BR-012.7	ROJO	12,70	6,40	0,64	25	232,00
NF201-BR-019.1	ROJO	19,10	9,50	0,77	25	448,00
NF201-BR-025.4	ROJO	25,40	12,70	0,89	15	573,00
NF201-BA-004.8	AZUL	4,80	2,40	0,51	50	105,00
NF201-BA-006.4	AZUL	6,40	3,20	0,64	25	124,00
NF201-BA-009.5	AZUL	9,50	4,70	0,64	25	170,00
NF201-BA-012.7	AZUL	12,70	6,40	0,64	25	232,00
NF201-BA-019.1	AZUL	19,10	9,50	0,77	25	448,00
NF201-BA-025.4	AZUL	25,40	12,70	0,89	15	573,00
NF201-BT-004.8	TIERRA	4,80	2,40	0,51	50	147,00
NF201-BT-006.4	TIERRA	6,40	3,20	0,64	25	174,00
NF201-BT-009.5	TIERRA	9,50	4,70	0,64	25	240,00
NF201-BT-012.7	TIERRA	12,70	6,40	0,64	25	325,00
NF201-BT-019.1	TIERRA	19,70	9,50	0,77	25	628,00
NF201-BT-025.4	TIERRA	25,40	12,70	0,89	15	802,00

FUNDA TERMORRETRÁCTIL 2:1 EN CAJA

Pared Fina

Heat Shrink Tubing 2:1 in Box | Thin Wall

COD	COLOR	Ø INTERIOR CONTRACCIÓN		ESPESOR	Mts.	€ X Caja
		ANTES	DESPUÉS			
NF201-CN-001.2	NEGRO	1,20	0,60	0,41	15	22,00
NF201-CN-001.6	NEGRO	1,60	0,80	0,43	15	22,00
NF201-CN-002.4	NEGRO	2,40	1,20	0,51	15	22,00
NF201-CN-003.2	NEGRO	3,20	1,60	0,51	15	22,00
NF201-CN-004.8	NEGRO	4,80	2,40	0,51	12	22,00
NF201-CN-006.4	NEGRO	6,40	3,20	0,64	12	22,00
NF201-CN-009.5	NEGRO	9,50	4,70	0,64	10	22,00
NF201-CN-012.7	NEGRO	12,70	6,40	0,64	8	22,00
NF201-CN-019.1	NEGRO	19,10	9,50	0,77	5	22,00
NF201-CN-025.4	NEGRO	25,40	12,70	0,89	3	22,00





FUNDA TERMORRETRÁCTIL EN ROLLO

Pared Fina

Heat Shrink Tubing in Roll | Thin Wall

COD	COLOR	Ø INTERIOR CONTRACCIÓN		ESPESOR	Mts. x (Ø)	€ x (Ø)
		ANTES	DESPUÉS			
NF201-RN-001.2	NEGRO	1,20	0,60	0,41	200	179,00
NF201-RN-001.6	NEGRO	1,60	0,80	0,43	200	196,00
NF201-RN-002.4	NEGRO	2,40	1,20	0,51	200	207,00
NF201-RN-003.2	NEGRO	3,20	1,60	0,51	200	228,00
NF201-RN-004.8	NEGRO	4,80	2,40	0,51	200	300,00
NF201-RN-006.4	NEGRO	6,40	3,20	0,64	150	257,00
NF201-RN-009.5	NEGRO	9,50	4,70	0,64	150	310,00
NF201-RN-012.7	NEGRO	12,70	6,40	0,64	100	222,00
NF201-RN-019.1	NEGRO	19,10	9,50	0,77	50	170,00
NF201-RN-025.4	NEGRO	25,40	12,70	0,89	50	245,00
NF201-RN-038.1	NEGRO	38,10	19,10	1,02	25	240,00
NF201-RN-050.4	NEGRO	50,40	25,20	1,14	25	320,00



FUNDA TERMORRETRÁCTIL 3:1 CON ADHESIVO EN BOLSA (1 metro)

Pared Fina

Heat Shrink Tubing 3:1 with adhesive in Bags (1 m.) | Thin Wall

COD	COLOR	Ø INTERIOR CONTRACCIÓN		ESPESOR	Unid. (x)	€ x 100/mts.
		ANTES	DESPUÉS			
NFD301-BN-003	NEGRO	3,00	1,00	0,55	30	245,00
NFD301-BN-004.8	NEGRO	4,80	1,60	0,60	30	290,00
NFD301-BN-006	NEGRO	6,00	2,00	0,70	24	350,00
NFD301-BN-009	NEGRO	9,00	3,00	0,70	20	465,00
NFD301-BN-012	NEGRO	12,00	4,00	0,70	16	630,00
NFD301-BN-018	NEGRO	18,00	6,00	0,80	10	950,00
NFD301-BN-024	NEGRO	24,00	8,00	1,00	6	1.500,00
NFD301-BN-039	NEGRO	39,00	13,00	1,15	4	3.100,00

FUNDA TERMORRETRÁCTIL 3:1 CON ADHESIVO EN BOLSA (1 metro)

Pared Media

Heat Shrink Tubing 3:1 with adhesive in Bags (1 m.) | Medium Wall

COD	COLOR	Ø INTERIOR CONTRACCIÓN		ESPESOR	Unid. (x)	€ x 100/mts.
		ANTES	DESPUÉS			
CRMA301-012	NEGRO	12,00	3,00	2,20	10	1.350,00
CRMA301-020	NEGRO	20,00	6,00	2,30	5	2.000,00
CRMA301-030	NEGRO	30,00	10,00	2,60	4	3.000,00
CRMA301-040	NEGRO	40,00	12,00	2,60	3	3.500,00
CRMA301-054	NEGRO	54,00	18,00	2,90	2	4.300,00
CRMA301-065	NEGRO	65,00	19,00	3,15	2	4.600,00
CRMA301-070	NEGRO	70,00	25,00	3,15	2	5.700,00
CRMA301-090	NEGRO	90,00	30,00	3,35	1	8.000,00
CRMA301-122	NEGRO	122,00	40,00	3,35	1	10.800,00
CRMA301-170	NEGRO	170,00	58,00	3,35	1	21.500,00



4

ABRAZADERAS METÁLICAS

Metallic Clamps





GRAPAS DOS PATAS

Double Foot Clips

COD	Ø mm.	Ø"	Unid. X	Unid.	€ x 100
9100	8	5/16	100	3.000	7,42
9101	10	3/8	100	3.000	7,77
9102	12	1/2	100	3.000	7,98
9103	14	9/16	100	1.200	8,86
9104	15	9/16	100	1.200	9,25
9105	16	5/8	100	1.200	9,75
9106	18	11/16	100	1.200	12,54
9107	20	13/16	100	600	13,50
9108	22	7/8	100	600	14,12
9109	25	1	100	600	14,80
9110	26	1 1/32	100	600	14,99
9111	28	1 1/8	100	600	15,95
9112	30	1 3/16	50	300	18,24
9113	32	1 1/4	50	300	18,98
9114	37	1 7/16	50	300	20,04
9115	40	1 9/16	50	300	21,44
9116	42	1 5/8	50	300	22,40
9117	47	1 7/8	50	200	30,72
9118	50	1 15/16	50	200	31,50
9120	60	2 23/64	50	200	35,84

GRAPAS UNA PATA

Single Foot Clips

COD	∅ mm.	∅"	Unid. 	Unid. 	€ x100
9000	6	1/4	100	6.000	4,04
9001	8	5/16	100	6.000	4,17
9002	10	3/8	100	6.000	4,98
9003	12	1/2	100	6.000	5,85
9004	14	9/16	100	3.000	6,13
9005	15	9/16	100	3.000	6,51
9006	16	5/8	100	3.000	7,10
9007	18	11/16	100	1.200	8,15
9008	20	13/16	100	1.200	9,60
9009	22	7/8	100	1.200	10,25
9010	25	1	100	1.200	11,44
9011	26	1 1/32	100	600	12,80
9012	28	1 1/8	100	600	13,16
9013	30	1 3/16	100	600	14,55
9014	32	1 1/4	100	600	15,82
9015	37	1 7/16	100	400	16,95
9016	40	1 9/16	50	300	21,06
9017	42	1 5/8	50	300	22,39
9018	47	1 7/8	50	300	24,22
9019	50	1 15/16	50	300	30,72

Grapa disparo página 96
Single foot clips page 96



ABRAZADERAS M6 CON TIRAFONDO

M6 Metallic Clamps with Screw

COD	∅ mm.	PG	∅"	Unid. K	Unid. K	€ x 100
10000	8	-	5/16	100	600	22,51
10001	10	-	3/8	100	600	22,82
10002	12	-	1/2	100	600	23,12
10003	14	-	9/16	100	600	24,04
10004	15	-	9/16	100	600	24,19
10005	16	9	5/8	100	600	24,89
10006	18	11	11/16	100	600	25,42
10007	20	13	13/16	100	600	25,65
10008	22	16	7/8	100	400	26,49
10009	24	-	15/16	100	400	26,64
10010	25	-	1	100	400	27,18
10011	28	21	1 1/8	100	400	28,15
10013	32	-	1 1/4	100	400	29,86
10014	35	-	1	50	300	35,16
10015	37	29	1 7/16	50	300	36,29
10012	40	-	1 9/16	50	300	38,28
10016	42	-	1 5/8	50	300	39,81
10017	47	36	1 7/8	50	200	44,40
10018	50	-	1 15/16	50	200	45,93
10019	54	-	-	50	200	49,90
10020	60	-	2 23/64	50	200	51,03
10021	63	-	2 31/64	50	200	54,44

ABRAZADERAS M6 DOBLES CON TIRAFONDO

Double M6 Metallic Clamps with Screw

COD	∅ mm.	Unid. K	Unid. K	€ x 100
13000	12	50	300	35,00
13001	15	50	300	36,69
13002	18	50	300	40,58
13003	22	50	200	44,29
13004	28	50	200	48,80

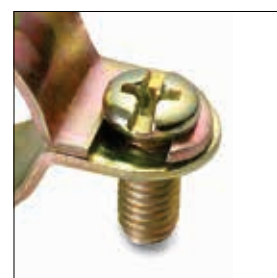



ABRAZADERAS M6

Single Clamps M6

COD	∅ mm.	PG	∅"	Unid.	Unid.	€ x 100
10100	8	-	5/16	100	1.200	14,80
10101	10	-	3/8	100	1.200	15,00
10102	12	-	1/2	100	1.200	15,33
10103	14	-	9/16	100	1.200	15,81
10104	15	-	9/16	100	1.200	15,94
10105	16	9	5/8	100	1.200	16,40
10106	18	11	11/16	100	600	17,04
10107	20	13	13/16	100	600	17,21
10108	22	16	7/8	100	600	17,69
10109	24	-	15/16	100	600	18,31
10110	25	-	1	100	600	18,59
10111	28	21	1 1/8	100	600	19,71
10113	32	-	1 1/4	100	600	21,94
10114	35	-	1	100	400	25,24
10115	37	29	1 7/16	100	400	26,80
10116	40	-	1 9/16	100	400	27,63
10200	42	-	1 5/8	50	300	30,55
10201	47	36	1 7/8	50	200	33,27
10202	50	-	1 15/16	50	200	34,63
10203	54	-	-	50	200	41,16
10204	60	-	2 23/64	50	200	44,10
10205	63	-	2 31/64	50	200	45,05



Cromada página 53
Chromated Clamp page 53

ABRAZADERAS DOBLES M6

Double Clamps M6

COD	∅ mm.	Unid.	Unid.	€ x 100
13010	12	50	600	28,00
13011	15	50	300	29,50
13012	18	50	300	32,03
13013	22	50	300	36,00
13014	28	50	200	45,08





ABRAZADERAS LAPAGAS DOBLES RUGOSAS M6

M6 Double Rugged Clamps

COD	∅ mm.	PG	∅"	Unid. K	Unid. M6	€ x 100
10550	12	-	1/2	50	300	46,00
10551	15-16	-	9/16	50	300	50,91
10552	18	11	11/16	50	300	53,83
10553	22	16	7/8	50	200	59,56
10554	28	21	1 1/8	50	200	68,41

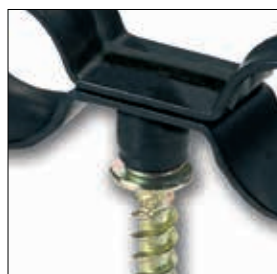

ABRAZADERAS LAPAGAS SIMPLES RUGOSAS M6

M6 Single Rugged Clamps

COD	∅ mm.	PG	∅"	Unid. K	Unid. M6	€ x 100
10531	12	-	1/2	100	600	30,31
10532	15	-	9/16	100	600	31,76
10533	18	11	11/16	100	600	32,89
10534	22	16	7/8	100	400	34,86
10535	28	21	1 1/8	100	400	39,13
10536	35	-	1 3/8	50	300	47,63
10537	42	-	1 5/8	50	300	51,34





ABRAZADERAS ISOFÓNICAS M6

Isophonic Metallic Clamps M6

COD	∅ mm.	Unid. 	Unid. 	€ x 100
10400	12	100	600	22,92
10401	15	100	600	25,20
10402	16	100	600	25,00
10403	18	100	600	26,78
10404	22	100	400	28,25
10405	26	50	300	33,08
10406	28	50	300	34,02
10407	32	50	300	38,96
10408	35	50	300	41,79
10409	42	25	150	55,86
10410	54	25	150	74,03



ABRAZADERAS ISOFÓNICAS DOBLES M6

Double Isophonic Metallic Clamps M6

COD	∅ mm.	Unid. 	Unid. 	€ x 100
13150	12	50	600	41,50
13151	15	50	300	46,95
13152	18	50	300	53,58
13153	22	50	300	59,00
13154	28	50	200	72,21





ABRAZADERAS DESAGÜE M8

Drain Pipe Clamps M8

COD	∅ mm.	Unid.	Unid.	€ x 100
22075	75	25	100	126,00
22090	90	25	25	132,00
22110	110	25	25	137,00
22125	125	25	25	149,00
22160	160	25	25	185,00
22200	200	25	25	275,00



ABRAZADERAS REFORZADAS M8/M10

Reinforced Pipe Clamps M8/M10

COD	Ref.	∅ max. mm.	Unid.	Unid.	€ x 100
10250	18	15-19	100	400	85,80
10251	22	20-25	100	100	87,55
10252	28	26-30	100	100	91,06
10253	35	32-36	100	100	95,90
10254	40-42	38-43	50	50	105,58
10255	48-50	47-51	50	50	110,36
10256	54	53-58	50	50	116,05
10257	60	60-64	50	50	133,65
10258	75	75-80	25	25	139,68
10259	90	87-92	25	25	149,48
10260	100	99-105	25	25	169,13
10261	110	107-112	25	25	180,95
10262	115	113-118	25	25	197,52
10263	125	125-130	25	25	214,67
10264	140	138-142	25	25	242,44
10265	160	159-166	25	25	265,74
10266	200	200-212	25	25	291,94



CINTA PERFORADA



Perforated Strap

COD		Mts. x	Unid.	€ x 100
11100	12x0,7	10	10	790,00
11101	17x0,7	10	10	820,00
11104	12x0,7 - Recta/straight	10	10	740,00
11105	17x0,7 - Recta/straight	10	10	850,00



ABRAZADERAS ISOFÓNICAS M8/M10



Isophonics Clamps M8/M10

COD	Ref.	∅ min./max. mm.	Unid. 	Unid. 	€ x 100
10300	18	15-19	50	200	105,08
10301	22	20-25	50	200	113,30
10302	28	26-30	50	50	115,71
10303	35	32-36	50	50	125,80
10304	40-42	38-43	25	100	139,64
10305	48-50	47-51	25	25	152,57
10306	54	53-58	25	25	174,52
10307	60	60-64	25	25	178,20
10309	75	75-80	25	25	202,62
10310	83	81-86	25	25	209,11
10311	90	87-92	25	25	216,37
10312	100	99-105	25	25	247,89
10313	110	107-112	25	25	255,00
10314	115	113-118	25	25	296,50
10315	125	125-130	25	25	311,74
10316	140	138-142	25	25	330,00
10317	160	159-166	25	25	352,00



ABRAZADERAS CONTRA INCENDIOS

Hanging Sprinkler

COD	∅ mm.	∅"	Unid. 	Unid. 	€ x 100
22702	35	1	50	50	102,00
22703	42	1 1/4	50	50	119,00
22704	48	1 1/2	50	50	127,00
22705	60	2	50	50	136,00
22706	75	2 1/2	50	50	156,00
22707	90	3	50	50	177,00
22708	115	4	50	50	230,00
22709	140	5	25	25	235,00
22710	160	6	25	25	243,00



ABRAZADERAS M6 CROMADA

Chromated M6 Clamps

COD	∅ mm.	∅"	Unid. 	Unid. 	€ x 100
10220	10	3/8	100	1.200	26,00
10221	12	1/2	100	1.200	30,20





ABRAZADERAS SIN-FIN

Hose Clamps

COD	∅ min./max. mm.	Unid.	Unid.	€ x 100
16012	8-16	100	1.200	51,81
16016	12-22	100	1.000	54,64
16024	16-25	100	600	58,91
16028	20-32	100	600	64,96
16036	25-40	100	400	70,00
16045	32-50	50	300	79,71
16052	40-60	50	200	87,22
16060	50-70	50	200	101,97
16082	70-90	25	100	118,75
16097	80-100	25	100	126,68
16112	90-110	25	100	157,04
16127	100-120	25	25	179,47
16142	120-140	25	25	219,08
16157	130-150	25	25	232,29



ABRAZADERA METÁLICA PARA BUTANO

Hose Clamps for Butane

COD	∅ min./max. mm.	Unid.	Unid.	€ x 100
16000	15-17	100	1.200	29,00



LAPAGAS AMARILLA M6 CON TIRAFONDO

M6 Yellow Lapagas

COD	∅ mm.	PG	∅"	Unid.	Unid.	€ x 100
10600	12	-	1/2	100	600	35,00
10601	15	-	9/16	100	600	37,92
10602	18	11	11/16	100	600	38,50
10603	22	16	7/8	100	400	40,25
10604	28	21	1 1/8	100	400	46,09
10605	35	-	1	50	300	55,00



LAPAGAS AMARILLA M8

M8 Yellow Lapagas

COD	Ref.	∅ max. mm.	Unid.	Unid.	€ x 100
10620	18	3/8	100	400	128,34
10621	22	1/2	100	100	137,67
10622	28	3/4	100	100	138,84
10623	35	1	100	100	142,34
10624	40-42	1 1/4	50	50	156,34
10625	48	1 1/2	50	50	168,00
10626	54	-	50	50	175,00
10627	60	2	50	50	192,50
10628	75	2 1/2	25	25	274,17
10629	90	3	25	25	291,67





GRAPA PUENTE ISOFÓNICA

Isophonic Clip

COD	∅ mm.	Nº	Unid. 	Unid. 	€ x 100
9200	15	3	50	50	50,00
9201	18	3	50	50	59,00
9202	22	3	50	50	65,00
9203	26	4	50	50	76,00
9204	35	4	50	50	95,00
9205	42	4	25	25	112,00
9206	48	4	25	25	132,00
9207	54	5	25	25	157,00
9208	60	5	25	25	168,00

ABRAZ. METAL

SOPORTE ISOFÓNICO

Support with Rubber



COD	Nº	mm.	Unid. 	Unid. 	€ x 100
9303	3	140	25	25	207,00
9305	5	190	25	25	272,00
9307	7	240	25	25	333,00
9308	8	265	25	25	369,00
9309	9	290	25	25	386,00
9310	10	315	25	25	403,00
9311	11	340	25	25	463,00
9312	12	365	25	25	493,00
9313	13	390	25	25	535,00
9314	14	415	25	25	580,00

TORNILLO

Screw



COD	mm.	Unid. 	Unid. 	€ x 100
9300	M6x15	100	6.000	13,00



5

SOPORTACIÓN

Supports

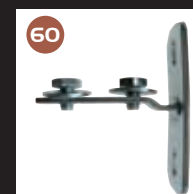



GUÍAS PERFORADAS LAPATRUT

Perforated Rail Lapatrut

COD	↑mm.→	↑ mm.	Unid. 	Unid. 	€ x 100
23250	41x21x3000	1,5	5	150	3.200,00
23251	41x21x3000	2,5	5	150	4.300,00
23252	41x41x3000	1,5	5	100	4.200,00
23253	41x41x3000	2,5	5	100	6.500,00
23254	41x62x3000	2,5	5	60	9.000,00

SOPORTES LAPATRUT 4IX2I

Support Lapatrut 4lx2l

COD	↑mm.→	↑ mm.	Unid. 	Unid. 	€ x 100
23260	150	2,5 mm.	20	20	1.350,00
23261	350	2,5 mm.	20	20	1.460,00
23262	450	2,5 mm.	10	10	1.725,00

SOPORTES LAPATRUT 4IX4I

Support Lapatrut 4lx4l

COD	↑mm.→	↑ mm.	Unid. 	Unid. 	€ x 100
23265	150	2,5 mm.	20	20	1.475,00
23266	350	2,5 mm.	20	20	1.665,00
23267	450	2,5 mm.	10	10	2.010,00
23268	600	2,5 mm.	10	10	2.275,00
23269	750	2,5 mm.	10	10	2.600,00

TORNILLOS GUÍA 27/28

Rail Screws 27/28

COD	↑mm.→	Unid. 	Unid. 	€ x 100
23230	M6x20	100	1.200	50,00
23231	M8x20	100	1.200	57,00
23232	M8x30	100	600	70,00

TORNILLOS GUÍA 38/40

Rail Screws 38/40

COD	↑mm.→	Unid. 	Unid. 	€ x 100
23233	M8x30	100	600	250,00
23234	M10x30	100	400	280,00

SOPORTES HORIZONTALES

Horizontal Supports

COD	↑mm.→	Unid. 	Unid. 	€ x 100
23240	27/18-28/30	25	100	800,00
23241	38/40	25	100	832,00

ACERO GALVANIZADO O PVC
GALVANIZED STEEL OR PVC



GUÍAS DE PLÁSTICO

Plastic Perforated Rail

COD RAL 7035	COD RAL 1004	↑mm.↓	Unid. 	Unid. 	€ x 100
23210	-	23x11x1000	10	2.500	375,00
-	23211	23x11x1000	10	2.500	290,00



GUÍAS METÁLICAS

Steel Perforated Rail

COD	↑mm.↓	Unid. 	Unid. 	€ x 100
23200	20x10x2000	10	1.000	500,00
23201	27x18x2000	10	750	850,00
23202	35x13x2000	10	600	1.350,00
23203	40x20x2000	10	500	1.300,00
23204	25x7,5x1000	50	2.400	415,00
23205	28x30x2000	10	250	2.275,00
23206	38x40x2000	6	192	3.200,00



CARRIL DIN

Din rails

COD	↑mm.↓	Unid. 	Unid. 	€ x 100
23215	35x7,5x2000	12	1.000	500,00
23216	35x7,5x2000	12	1.000	500,00
23217	35x15x2000	12	500	900,00
23218	35x15x2000	12	500	900,00



TOPES GUÍAS

Rail Stops

COD RAL 7035	COD RAL 9005	Unid. 	Unid. 	€ x 100
23300	23301	100	3.000	45,43



SOPORTES

Supports

COD	↑mm.↓	mm.	Unid. 	Unid. 	€ x 100
23220	27x18x200	1,25 mm.	20	20	530,00
23221	27x18x300	1,25 mm.	20	20	625,00
23223	38x40x400	2 mm.	10	10	1.200,00
23224	40x60x475	2,5 mm.	1	1	2.600,00



ESCUADRA / EMPALME

Square / Connector

COD	Ref.	Unid. 	Unid. 	€ x 100
23235	90°	100	400	155,00
23238	180°	25	300	155,00



6

ANCLAJES

Anchors





ANCLAJE DE ACERO LP 6.8 ZINCADO BLANCO

Sleeve Anchors Lp 6.8 | White Plated

COD	Ref.	↑mm.	Unid. 	Unid. 	€ x 100
15106	LPT08C	M6X45-Ø8	200	1.200	21,00
15107	LPT08L	M6X60-Ø8	200	1.200	24,00
15100	LPT09C	M6X45-Ø9	200	1.200	22,00
15101	LPT09L	M6X60-Ø9	200	1.200	25,50
15108	LPT10C	M8X60-Ø10	100	600	39,50
15120	LPT10M	M8X70-Ø10	100	600	42,00
15109	LPT10L	M8X80-Ø10	100	600	48,00
15102	LPT11C	M8X60-Ø11	100	600	42,00
15121	LPT11M	M8X70-Ø11	100	600	45,00
15103	LPT11L	M8X80-Ø11	100	600	51,00
15110	LPT12C	M10X70-Ø12	100	400	67,00
15111	LPT12L	M10X100-Ø12	50	300	76,60
15104	LPT14C	M10X70-Ø14	100	400	72,40
15105	LPT14L	M10X100-Ø14	50	300	88,30
15112	LPT16C	M12X80-Ø16	50	300	99,90
15113	LPT16L	M12X110-Ø16	50	200	125,00
15114	LPT20C	M16X110-Ø20	25	100	295,00
15115	LPT20L	M16X130-Ø20	25	100	399,00

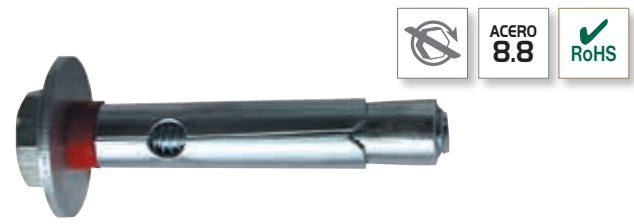

ANCLAJE DE ACERO LP 8.8 ZINCADO BLANCO

Sleeve Anchors Lp 8.8 | White Plated

COD	Ref.	↑mm.	Unid. 	Unid. 	€ x 100
15150	LPTR08C	M6X45-Ø8	200	1.200	26,80
15151	LPTR08L	M6X60-Ø8	200	1.200	31,93
15152	LPTR09C	M6X45-Ø9	200	1.200	29,25
15153	LPTR09L	M6X60-Ø9	200	1.200	34,02
15154	LPTR10C	M8X60-Ø10	100	600	44,41
15155	LPTR10M	M8X70-Ø10	100	600	51,39
15156	LPTR10L	M8X80-Ø10	100	600	57,67
15157	LPTR11C	M8X60-Ø11	100	600	48,04
15158	LPTR11M	M8X70-Ø11	100	600	55,10
15159	LPTR11L	M8X80-Ø11	100	600	61,05
15160	LPTR12C	M10X70-Ø12	100	400	74,63
15163	LPTR12L	M10X100-Ø12	50	300	93,89
15164	LPTR14C	M10X70-Ø14	100	400	79,87
15167	LPTR14L	M10X100-Ø14	50	300	100,04
15168	LPTR16C	M12X80-Ø16	50	300	115,21
15170	LPTR16L	M12X110-Ø16	50	200	171,22
15171	LPTR20C	M16X110-Ø20	25	100	305,00
15172	LPTR20L	M16X130-Ø20	25	100	418,48



ANCLAJE DE ACERO LP GANCHO ZINCADO BLANCO

Sleeve Anchors Lp Hook | White Plated

COD	Ref.	↑mm.	Unid. 	Unid. 	€ x 100
15202	LPG08	M6X45-Ø8	100	600	40,00
15200	LPG09	M6X45-Ø9	100	600	44,00
15203	LPG10	M8X60-Ø10	100	400	71,00
15201	LPG11	M8X60-Ø11	100	400	77,00
15204	LPG12	M10X70-Ø12	50	200	116,00
15205	LPG14	M10X70-Ø14	50	200	132,00
15206	LPG16	M12X80-Ø16	25	150	210,00



ANCLAJE DE ACERO LP ARO ZINCADO BLANCO

Sleeve Anchors Lp with Eye | White Plated

COD	Ref.	↑mm.	Unid. 	Unid. 	€ x 100
15302	LPA08	M6X45-Ø8	100	600	40,00
15300	LPA09	M6X45-Ø9	100	600	44,00
15303	LPA10	M8X60-Ø10	100	400	71,00
15301	LPA11	M8X60-Ø11	100	400	77,00
15304	LPA12	M10X70-Ø12	50	200	116,00
15305	LPA14	M10X70-Ø14	50	200	132,00
15306	LPA16	M12X80-Ø16	25	150	210,00



ANCLAJE DE ACERO LP INVOLABLE ZINCADO BLANCO

Tamper Proof Lp | White Plated

COD	Ref.	↑mm.	Unid. 	Unid. 	€ x 100
15600	LPIZ08C	M6X45-Ø8	100	1.200	37,92
15601	LPIZ08L	M6X60-Ø8	100	1.200	39,99
15602	LPIZ09C	M6X45-Ø9	100	1.200	38,84
15603	LPIZ09L	M6X60-Ø9	100	1.200	41,38
15604	LPIZ10C	M8X60-Ø10	100	600	62,00
15606	LPIZ10L	M8X80-Ø10	100	600	72,00
15607	LPIZ11C	M8X60-Ø11	100	600	68,00
15609	LPIZ11L	M8X80-Ø11	100	600	76,00

ANCLAJE DE ACERO LP INVOLABLE ZINCADO NEGRO

Tamper Proof Lp | Black Plated

COD	Ref.	↑mm.	Unid. 	Unid. 	€ x 100
15620	LPIN08C	M6X45-Ø8	100	1.200	40,29
15621	LPIN08L	M6X60-Ø8	100	1.200	42,49
15622	LPIN09C	M6X45-Ø9	100	1.200	41,21
15623	LPIN09L	M6X60-Ø9	100	1.200	43,87
15624	LPIN10C	M8X60-Ø10	100	600	65,00
15626	LPIN10L	M8X80-Ø10	100	600	75,00
15627	LPIN11C	M8X60-Ø11	100	600	70,00
15629	LPIN11L	M8X80-Ø11	100	600	85,00

ANCLAJE DE ACERO LP ESPÁRRAGO ZINCADO BLANCO

Lp Threaded Rod | White Plated

COD	Ref.	↑mm.	Unid. 	Unid. 	€ x 100
15005	LPE08C	M6X45-Ø8	200	1.200	26.06
15006	LPE08L	M6X60-Ø8	200	1.200	27.82
15000	LPE09C	M6X45-Ø9	200	1.200	27.23
15007	LPE09L	M6X60-Ø9	200	1.200	30.47
15008	LPE10C	M8X60-Ø10	100	600	40.87
15010	LPE10L	M8X80-Ø10	100	600	47.95
15001	LPE11C	M8X60-Ø11	100	600	42.57
15002	LPE11L	M8X80-Ø11	100	600	50.36
15012	LPE12C	M10X70-Ø12	100	400	65.60
15015	LPE12L	M10X100-Ø12	50	300	78.44
15003	LPE14C	M10X70-Ø14	100	400	76.00
15004	LPE14L	M10X100-Ø14	50	300	89.90



ANCLAJE DE ACERO LP INOX A2

Stainless Steel Sleeve Anchors A2

COD	Ref.	↑mm.	Unid. 	Unid. 	€ x 100
15250	LPTIX08C	M6X45-Ø8	100	1.200	95,57
15251	LPTIX08L	M6X60-Ø8	100	1.200	107,34
15254	LPTIX10C	M8X60-Ø10	100	600	150,93
15255	LPTIX10L	M8X80-Ø10	100	600	202,40
15258	LPTIX12C	M10X70-Ø12	50	300	272,80
15259	LPTIX12L	M10X100-Ø12	25	300	418,00
15262	LPTIX16C	M12X80-Ø16	25	150	539,00
15263	LPTIX16L	M12X110-Ø16	25	100	643,11





ANCLAJE DE ACERO LP TORNILLO DIN 7991 ZINCADO BLANCO

Lp Screw DIN 7991 | White Plated

COD	Ref.	mm.	Unid.	Unid.	€ x 100
15650	LPTP08C	M6X45-Ø8	100	1.200	35,00
15651	LPTP08L	M6X60-Ø8	100	1.200	55,72
15652	LPTP09C	M6X45-Ø9	100	1.200	36,00
15653	LPTP09L	M6X60-Ø9	100	1.200	57,00
15654	LPTP10C	M8X60-Ø10	100	600	62,00
15655	LPTP10M	M8X70-Ø10	100	600	87,29
15656	LPTP10L	M8X80-Ø10	100	600	84,10
15657	LPTP11C	M8X60-Ø11	100	600	68,10
15658	LPTP11M	M8X70-Ø11	100	600	90,38
15659	LPTP11L	M8X80-Ø11	100	600	113,29

CONJUNTO DE ANCLAJE DE ACERO ZINCADO BLANCO

Anchor Shield Set | White Plated

COD	Ref.	mm.	Unid.	Unid.	€ x 100
814000	08C	30	200	1.200	18,87
814001	08L	45	200	1.200	20,75
814002	09C	30	200	1.200	21,23
814003	09L	45	200	1.200	22,99
814004	10C	42	100	600	25,07
814005	10L	63	100	600	28,88
814006	11C	42	100	600	29,18
814007	11L	63	100	600	33,13
814008	12C	48	100	400	33,90
814009	12L	75	50	600	37,73
814010	14C	48	100	400	41,61
814011	14L	75	50	300	57,20
814012	16C	55	50	300	61,19
814013	16L	55+30	50	200	73,10



CONJUNTO DE ANCLAJE DE INOX A2

Anchor Shield set in A2

COD	Ref.	mm.	Unid.	Unid.	€ x 100
814060	08C	30	100	1.200	55,00
814061	08L	45	100	1.200	60,50
814064	10C	42	100	600	88,00
814065	10L	63	50	600	101,20
814068	12C	48	50	300	136,40
814069	12L	75	25	300	155,10
814072	16C	55	25	150	275,00
814073	16L	55+30	25	100	385,00

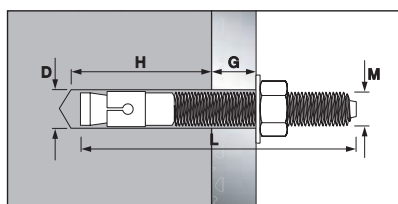

PERNOS DE ANCLAJE

Wedge Anchor

COD	M mm	D mm	H mm	G mm	L mm	Unid. 	Unid. 	€ x 100
15440	M6	6	40	2	45	100	2.400	22,70
15441	M6	6	40	10	60	100	2.400	25,00
15442	M6	6	40	36	80	100	1.200	29,80
15443	M8	8	45	3	50	100	1.200	33,50
15444	M8	8	45	20	75	100	600	39,50
15445	M8	8	45	40	90	100	600	43,30
15446	M8	8	45	60	115	100	400	50,00
15447	M10	10	50	3	65	100	600	50,60
15448	M10	10	50	15	90	100	400	57,84
15449	M10	10	50	35	100	100	400	64,00
15450	M10	10	50	60	120	50	300	72,90
15451	M12	12	60	5	75	50	300	74,80
15452	M12	12	60	22	110	50	300	90,20
15453	M12	12	60	50	140	50	200	103,80
15454	M12	12	60	100	180	50	300	136,00
15455	M16	16	65	20	100	25	200	165,00
15456	M16	16	65	36	125	25	100	188,80
15457	M16	16	65	70	145	25	100	207,00
15458	M16	16	65	90	170	25	50	248,00
15459	M16	16	65	120	220	20	80	294,00
15460	M20	20	80	45	170	20	40	361,00
15461	M20	20	80	90	220	10	20	428,00



PERNO DE TECHO CON ARO

Ceiling Wire Hanger

COD		mm.	Unid. 	Unid. 	€ x 100
SRS-06063	6	63	10	80	25,00



PERNO DE TECHO

Ceiling Wedge Anchor

COD		mm.	Unid. 	Unid. 	€ x 100
GS-06040	6	40	100	1.800	19,70
GS-06065	6	65	100	1.200	34,50



ANCLAJE RÁPIDO DE TECHO

Ceiling Spring Pin

COD		mm.	Unid. 	Unid. 	€ x 100
Z-KSP	8	42	100	2.000	26,00



PERNOS DE ANCLAJE R-XPT HOMOLOGADOS ZINCADO BLANCO

Wedge Anchor R-XPT with Approval | White Plated

COD	↑mm.	Unid.	€ x 100
R-XPT-06050/10	M6 x 50	100	51,48
R-XPT-06065/5	M6 x 65	100	51,48
R-XPT-06085/25	M6 x 85	100	51,48
R-XPT-06100/40	M6 x 100	100	57,20
R-XPT-08065/15	M8 x 65	100	62,92
R-XPT-08080/15	M8 x 80	100	68,64
R-XPT-08095/30	M8 x 95	100	80,08
R-XPT-08115/50	M8 x 115	100	91,52
R-XPT-10065/5	M10 x 65	50	91,52
R-XPT-10080/10	M10 x 80	50	102,96
R-XPT-10095/25	M10 x 95	50	97,24
R-XPT-10115/45	M10 x 115	50	120,12
R-XPT-10130/60	M10 x 130	50	131,56
R-XPT-12080/5	M12 x 80	50	131,56
R-XPT-12100/5	M12 x 100	50	143,00
R-XPT-12120/25	M12 x 120	50	160,16
R-XPT-12150/55	M12 x 150	50	177,32
R-XPT-12180/85	M12 x 180	50	240,24
R-XPT-12220/125	M12 x 220	50	1.447,16
R-XPT-12300/205	M12 x 300	25	1.830,40
R-XPT-16090/10	M16 x 90	25	183,04
R-XPT-16105/10	M16 x 105	25	263,12
R-XPT-16125/5	M16 x 125	25	234,52
R-XPT-16140/20	M16 x 140	25	274,56
R-XPT-16180/60	M16 x 180	25	297,44
R-XPT-16220/100	M16 x 220	25	1.355,64
R-XPT-16280/160	M16 x 280	25	1.716,00
R-XPT-20125/5	M20 x 125	25	640,64
R-XPT-20160/20	M20 x 160	25	720,72
R-XPT-20200/60	M20 x 200	10	1.578,72
R-XPT-20300/160	M20 x 300	10	2.110,68
R-XPT-24180/20	M24 X 180	10	1.870,44
R-XPT-24260/100	M24 X 260	10	2.516,80
R-XPT-24300/140	M24 X 300	10	2.825,68

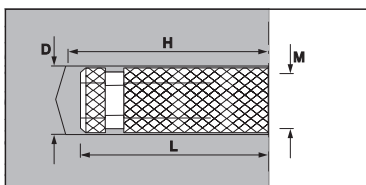

ANCLAJE DE LATÓN

Brass Anchor

COD	M mm	D mm	L mm	Unid.	Unid.	€ x 100
5020	M-4	5	16	200	12.000	11,00
5021	M-5	6	20	200	12.000	18,17
5022	M-6	8	23	100	6.000	24,90
5023	M-8	10	28	100	3.000	48,13
5024	M-10	12	33	50	1.500	105,00



PERNOS DE ANCLAJE R-XPT HOMOLOGADOS INOXIDABLES A-4

Wedge Anchor R-XPT with Approval | Stainless Steel A4

COD	↑mm.	Unid.	€ x 100
R-XPT-A4-06050/10	M6 x 50	100	155,93
R-XPT-A4-06085/25	M6 x 85	100	184,80
R-XPT-A4-08060/10	M8 x 60	100	213,70
R-XPT-A4-08075/10	M8 x 75	100	236,78
R-XPT-A4-08095/30	M8 x 95	100	259,88
R-XPT-A4-08115/50	M8 x 115	100	282,98
R-XPT-A4-10080/10	M10 x 80	50	352,28
R-XPT-A4-10095/25	M10 x 95	50	381,15
R-XPT-A4-10115/45	M10 x 115	50	421,58
R-XPT-A4-10140/70	M10 x 140	50	473,55
R-XPT-A4-12100/5	M12 x 100	50	577,50
R-XPT-A4-12125/30	M12 x 125	50	652,58
R-XPT-A4-12150/55	M12 x 150	50	727,65
R-XPT-A4-16125/5	M16 x 125	25	1.189,65
R-XPT-A4-16150/30	M16 x 150	25	1.322,48
R-XPT-A4-16180/60	M16 x 180	25	1.484,18
R-XPT-A4-16220/100	M16 x 220	25	3.736,43
R-XPT-A4-20125/5	M20 x 125	25	1.980,83
R-XPT-A4-20160/20	M20 x 160	25	2.263,80
R-XPT-A4-20200/60	M20 x 200	10	5.653,73
R-XPT-A4-20300/160	M20 x 300	10	8.160,08
R-XPT-A4-24260/160	M24 x 260	10	11.480,70

Disponible en galvanizado en caliente sobre pedido
Hot galvanized by order



ANCLAJE HEMBRA R-DCA ZINCADO BLANCO

Drop in Anchor | White Plated

COD	M mm	D mm	L mm	H mm	Unid. 	Unid. 	€ x 100
R-DCA-06-25	M6	8	25	27	100	1.500	22,00
R-DCA-08-30	M8	10	30	32	100	1.000	33,00
R-DCA-10-40	M10	12	40	42	100	1000	50,00
R-DCA-12-50	M12	15	50	52	50	250	89,00
R-DCA-16-65	M16	20	65	67	50	100	215,00
R-DCA-20-80	M20	25	80	82	50	100	432,00

ANCLAJE HEMBRA ZINCADO BLANCO

Drop in Anchor | White Plated

COD	M mm	D mm	L mm	H mm	Unid. 	Unid. 	€ x 100
5030	M6	8	25	27	100	1.000	14,50
5031	M8	10	30	32	100	1.000	18,00
5032	M10	12	40	42	50	500	32,50
5033	M12	15	50	52	50	400	66,25

ANCLAJE HEMBRA R-DCA INOXIDABLE A4

Stainless Steel A4 Drop in Anchor

COD	M mm	D mm	L mm	H mm	Unid. 	Unid. 	€ x 100
R-DCA-06-25-A4	M6	8	25	27	100	1.000	230,00
R-DCA-08-30-A4	M8	10	30	32	100	1.000	310,00
R-DCA-10-40-A4	M10	12	40	42	50	500	465,00
R-DCA-12-50-A4	M12	15	50	52	50	400	865,00
R-DCA-16-65-A4	M16	20	65	67	25	150	1.990,00

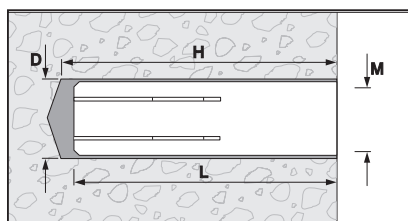

ANCLAJE HEMBRA R-DCL CON COLLARÍN ZINCADO BLANCO

Drop in Anchor with collar | White Plated

COD	M mm	D mm	L mm	H mm	Unid. 	Unid. 	€ x 100
R-DCL-06	M6	8	25	27	100	1.000	26,00
R-DCL-08	M8	10	30	32	100	1.000	37,00
R-DCL-10	M10	12	40	42	50	100	58,00
R-DCL-12	M12	15	50	52	50	400	100,00
R-DCL-16	M16	20	65	67	25	150	235,00



RETACADOR MANUAL PARA R-DCA Y R-DCL

Manual Setting Tool for R-DCA and R-DCL

COD		Unid. 	Unid. 	€ x 100
R-DCA-ST-06	M6	1	1	340,00
R-DCA-ST-08	M8	1	1	420,00
R-DCA-ST-10	M10	1	1	645,00



6 ANCLAJES DE ACERO DE ALTO RENDIMIENTO

ANCHORS



CÁPSULA ACERO

Steel Shield

COD	Ref.		Unid.	Unid.	€ x 100
15500	LPZC06	12	100	1.200	77,11
15501	LPZC08	14	100	600	96,69
15502	LPZC10	16	50	600	150,26
15503	LPZC12	20	25	300	294,29



ACERO TORNILLO CALIDAD 6.8

Steel Screw 6.8

COD	Ref.		Unid.	Unid.	€ x 100
15510	LPZT06	12	100	600	85,96
15511	LPZT08	14	100	600	113,89
15512	LPZT10	16	50	300	186,16
15513	LPZT12	20	25	150	348,96



ACERO TORNILLO CALIDAD 8.8

Steel Screw 8.8

COD	Ref.		Unid.	Unid.	€ x 100
15550	LPZTR06	12	100	600	78,44
15551	LPZTR08	14	100	600	108,00
15552	LPZTR10	16	50	300	154,01
15553	LPZTR12	20	25	150	299,54



ACERO ESPÁRAGO

Steel Threaded Rod

COD	Ref.		Unid.	Unid.	€ x 100
15520	LPZE06	12	100	600	90,55
15521	LPZE08	14	100	400	122,74
15522	LPZE10	16	50	300	200,91
15523	LPZE12	20	25	100	310,66



ACERO ARGOLLA

Steel Bolt with Eye

COD	Ref.		Unid.	Unid.	€ x 100
15540	LPZA06	12	100	600	87,60
15541	LPZA08	14	100	400	126,90
15542	LPZA10	16	50	300	199,03
15543	LPZA12	20	25	100	372,67



ACERO GANCHO

Steel Bolt with Hook

COD	Ref.		Unid.	Unid.	€ x 100
15530	LPZG06	12	100	600	87,60
15531	LPZG08	14	100	400	126,90
15532	LPZG10	16	50	300	199,03
15533	LPZG12	20	25	100	372,67

ANCLAJES



ANCLAJES R-SPL SAFETYPLUS™ GRANDES CARGAS TORNILLO

R-SPL Safetyplus Loose Bolt for Ultimate Loads

COD	M mm	D mm	H mm	G mm	L mm	Unid. 	€ x 100
R-SPL-08090/15	M8	12	80	15	90	50	370,44
R-SPL-08110/40	M8	12	80	40	110	50	411,60
R-SPL-10105/20	M10	15	90	20	105	50	446,88
R-SPL-10120/40	M10	15	90	40	120	50	464,52
R-SPL-10140/60	M10	15	90	60	140	50	493,92
R-SPL-12120/25	M12	18	105	25	120	25	588,00
R-SPL-12150/50	M12	18	105	50	150	25	723,24
R-SPL-16145/25	M16	24	125	25	145	10	1.393,11
R-SPL-16170/50	M16	24	125	50	170	10	1.546,44
R-SPL-20175/30	M20	28	155	30	175	10	2.659,57

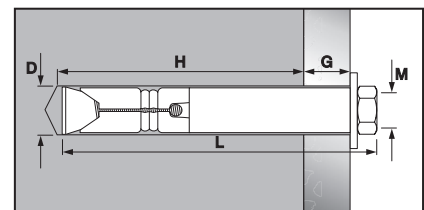

ANCLAJES R-SPL SAFETYPLUS™ GRANDES CARGAS ESPÁRRAGO

R-SPL Safetyplus Projecting Bolt for Ultimate Loads

COD	M mm	D mm	H mm	G mm	L mm	Unid. 	€ x 100
R-SPL-BP-08095/15	M8	12	80	15	95	50	517,44
R-SPL-BP-10110/20	M10	15	90	20	110	50	529,20
R-SPL-BP-12135/25	M12	18	105	25	135	25	729,12
R-SPL-BP-12160/50	M12	18	105	50	160	25	1.176,00
R-SPL-BP-16160/25	M16	24	125	25	160	10	1.716,96
R-SPL-BP-16185/50	M16	24	125	50	185	10	1.787,52
R-SPL-BP-20190/30	M20	30	155	30	190	10	2.593,08



ANCLAJES R-SPL SAFETYPLUS™ GRANDES CARGAS TORNILLO DIN 7991





R-SPL Safetyplus Countersunk Bolt for Ultimate Loads

COD	M mm	D mm	H mm	G mm	L mm	Unid. 	€ x 100
R-SPL-C-08090/20	M8	12	80	15	90	10	441,00
R-SPL-C-10105/25	M10	15	90	20	105	10	505,68
R-SPL-C-12125/30	M12	18	105	25	125	15	717,36
R-SPL-C-16145/30	M16	24	125	25	145	10	1.399,44



ANCLAJE EN ACERO INOX A2 EN CAJA PEQUEÑA





Stainless Steel Sleeve Anchor in Little Box

COD	Ref.			mm.	Unid. 	Unid. 	€ x 100
15270	LPTIX08C	8	6	45	20	480	95,00
15271	LPTIX08L	8	6	60	20	480	102,00
15274	LPTIX10C	10	8	60	20	480	154,00
15275	LPTIX10L	10	8	80	20	480	203,00
15278	LPTIX12C	12	10	70	10	240	282,00
15279	LPTIX12L	12	10	100	10	240	420,00
15282	LPTIX16C	16	12	80	10	120	540,00
15283	LPTIX16L	16	10	110	10	120	630,00



ANCLAJE TORNILLO LP 6.8 EN CAJA PEQUEÑA





Sleeve Anchors Lp 6.8 in Little Box

COD	Ref.			mm.	Unid. 	Unid. 	€ x 100
15130	LPT08C	8	6	45	20	480	29,00
15131	LPT08L	8	6	60	20	480	33,00
15132	LPT09C	9	6	45	20	480	31,00
15133	LPT09L	9	6	60	20	480	35,00
15134	LPT010C	10	8	60	20	480	51,00
15135	LPT010L	10	8	80	20	480	52,00
15136	LPT011C	11	8	60	20	480	51,50
15137	LPT011L	11	8	80	20	480	57,00
15138	LPT012C	12	10	70	10	240	71,00
15139	LPT012L	12	10	100	10	240	86,00
15140	LPT014C	14	10	70	10	120	80,00
15141	LPT014L	14	10	100	10	120	96,00
15142	LPT016C	16	12	80	10	120	111,00
15143	LPT016L	16	12	110	10	120	145,00



LP ARGOLLA EN CAJA PEQUEÑA





Stainless Steel Sleeve Anchor in Little Box

COD	Ref.			mm.	Unid. 	Unid. 	€ x 100
15330	LPA08C	8	6	45	20	480	43,00
15331	LPA09C	9	6	45	20	480	44,00
15332	LPA10C	10	8	60	10	240	78,00
15333	LPA11C	11	8	60	10	240	80,00
15334	LPA12C	12	10	70	5	120	144,00
15335	LPA14C	14	10	70	5	60	154,00
15336	LPA16C	16	12	80	5	60	261,00



LP GANCHO EN CAJA PEQUEÑA

Stainless Steel Sleeve Anchor in Little Box

COD	Ref.			mm.	Unid. 	Unid. 	€ x 100
15230	LPG08C	8	6	45	20	480	43,00
15231	LPG09C	9	6	45	20	480	44,00
15232	LPG10C	10	8	60	10	240	78,00
15233	LPG11C	11	8	60	10	240	80,00
15234	LPG12C	12	10	70	5	120	144,00
15235	LPG14C	14	10	70	5	60	154,00
15236	LPG16C	16	12	80	5	60	261,00



ANCLAJES

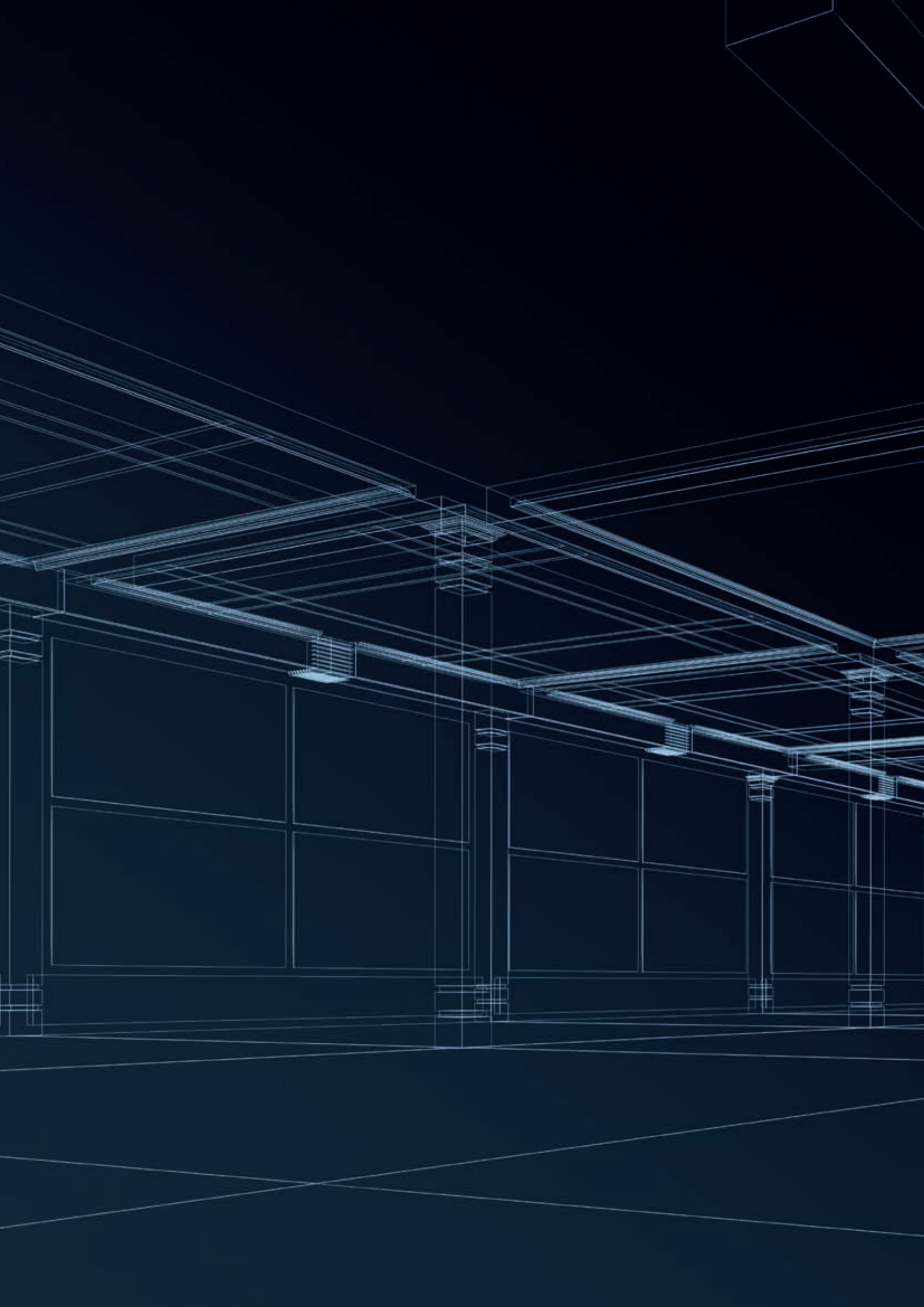

7

FIJACIONES QUÍMICAS

Chemical Fixings

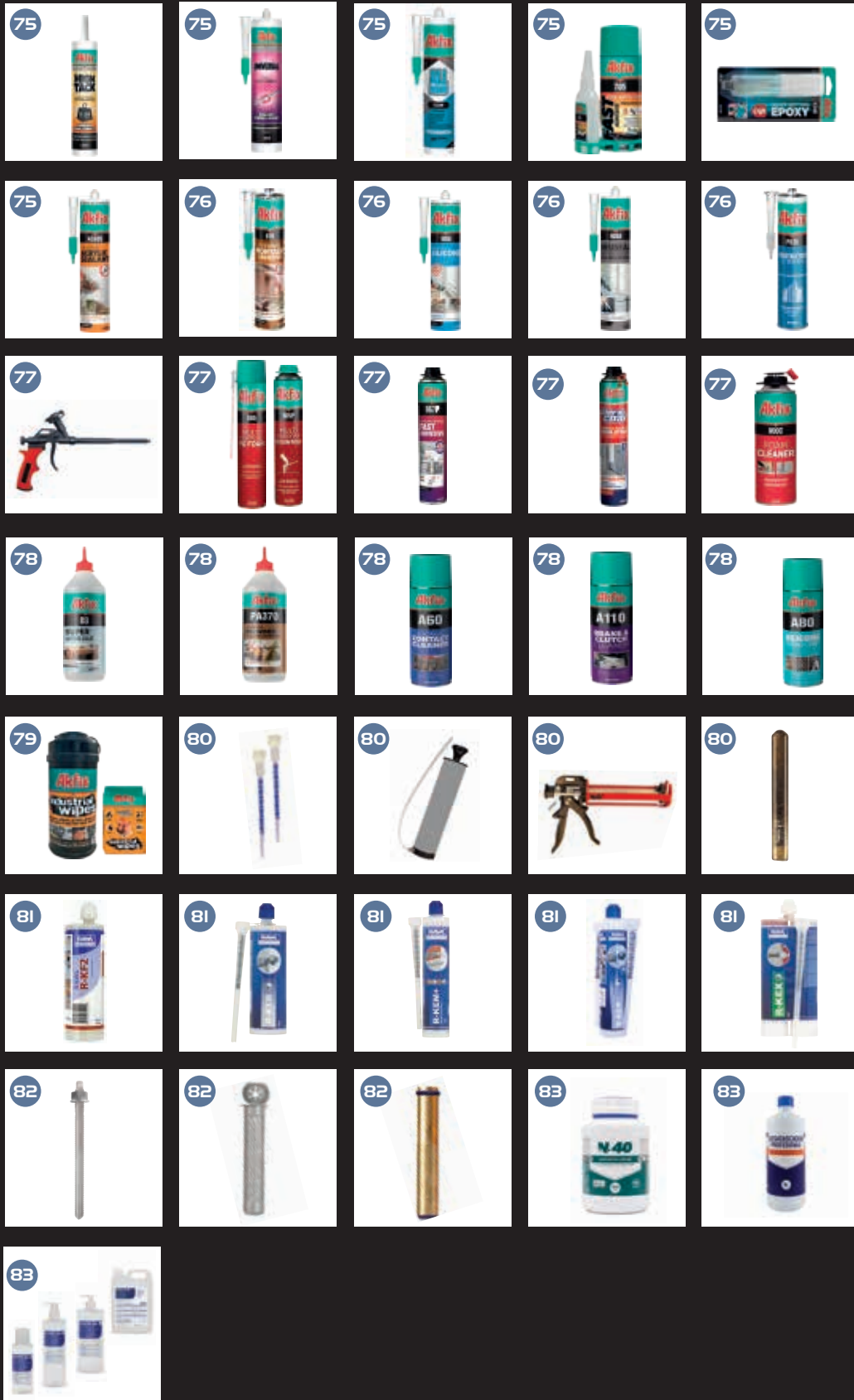

MULTIUSOS DE ALTA ADHERENCIA

HIGH TACK



QUÍMICO

HIGH TACK MULTIUSO DE ALTA ADHERENCIA

HIGH TACK Multi purpose Adhesive with high bonding strenght

COD	ml.		 Unid.	€ x Unid.
HIGH TACK	290	BOTE	12	17,00

Sellador híbrido con una alta fuerza adhesiva y agarre inicial para múltiples aplicaciones.
Hybrid adhesive with high bonding strenght and initial tack for multiple applications.



HIGH TACK MULTIUSO DE ALTA ADHERENCIA

HIGH TACK Multi purpose Adhesive with high bonding strenght

COD	ml.		Unid.	€ x Unid.
HICH TACK	290	BOTE	12	17,00

Sellador híbrido con una alta fuerza adhesiva y agarre inicial para múltiples aplicaciones.
Hybrid adhesive with high bonding strenght and initial tack for multiple applications.



ALLBOND MS UNIVERSAL

Allbond MS universal

COD	ml.		Unid.	€ x Unid.
ALLBOND 290	290	BOTE	12	13,50

Polímero con tecnología MS, monocomponente, sellador híbrido, apto para múltiples aplicaciones.
Polymer with ms technology, one component hybrid sealant, suitable for multiple applications.



ALLBOND UNIVERSAL TRANSPARENTE

Transparent universal allbond TR

COD	ml.		Unid.	€ x Unid.
ALLBOND-290TR	290	BOTE	12	19,50

Polímero con tecnología ms de sellador híbrido transparente monocomponente. Adecuado para múltiples aplicaciones.
Polymer with ms technology of one component, transparent hybrid sealant. Suitable for multiple applications.



ADHESIVO RÁPIDO UNIVERSAL

Universal fast adhesive

COD	ml.	gr.		Unid.	€ x Unid.
705-50	200	50	BOTE	24	17,00

Adhesivo rápido de dos componentes de cianocrilato de alta viscosidad y activador. Apto para múltiples aplicaciones.
Cyanoacrylate adhesive + activator. High bonding and high speed curing for all kind of applications.



ADHESIVO EXPOSY BICOMPONENTE

Two components epoxy adhesive

COD	ml.		Unid.	€ x Unid.
E340	25	BOTE	12	14,00

Adhesivo esposy de dos componentes, curado rápido apto para múltiples aplicaciones.
Epoxy based adhesive of two components, fast curing and for multipurpose applications.



MASILLA ACRÍLICA

Acrylic sealant



COD	ml.		Unid.	€ x Unid.
AC605	310	BOTE	24	4,00

Sellador acrílico universal de un solo componente para rellenar grietas y juntas en interior y exterior.
Universal acrylic sealant of one component to fill cracks and joints both indoors and outdoors. sandable & paintable.



ADHESIVO DE POLIURETANO

Transparent pu montage adhesive

COD	COLOR	ml.		Unid. 	€ x Unid.
610	TRANSPARENTE	310	BOTE	12	14,00



Adhesivo monocomponente a base de poliuretano de curado rápido. Alta fuerza de unión inicial y curado rápido. Para todo tipo de materiales de construcción.

Single component, fast curing polyurethane based adhesive. High initial bond strength and fast curing. For all kind of construction materials.



SILICONA ACÉTICA

Acetoxysilicone sealant

COD	COLOR	ml.		Unid. 	€ x Unid.
100E-BL	BLANCA	280	BOTE	24	6,80
100E-TR	TRANSP.	280	BOTE	24	6,80



Sellador de silicona con acetoxia de un componente. fuerte adhesión, permanentemente elástico después del curado. Blanco y transparente.

One component acetoxysilicone sealant. Strong adhesion, stays permanently elastic after curing. white and transparent.



SILICONA NEUTRA

Neutral silicone

COD	COLOR	ml.		Unid. 	€ x Unid.
905E-BL	BLANCA	300	BOTE	24	9,10
905E-TR	TRANSP.	300	BOTE	24	9,10



Silicona de un componente curado con humedad. Excelente en superficies porosas y no porosas. Especialmente indicado para uso exterior en ventanas y fachadas.

ONE component silicone curing with humidity. Excellent in porous and non-porous surfaces. Specially indicated for outside use on windows and facades.



ADHESIVO DE CONSTRUCCIÓN

Construction sealant

COD		ml.		Unid. 	€ x Unid.
P635-310-B	○	280	BOTE	24	13,50
P635-310-B	●	280	BOTE	12	13,50
P635-310-B	●	280	BOTE	12	13,50

Sellador elástico de poliuretano que cura por exposición a la humedad atmosférica. excelente adhesión a todos los materiales de construcción.

Elastic pu sealant that cures on exposure to atmospheric humidity. excellent adhesion to all construction materials.



PISTOLA ESPUMA TEFLONEADA

Gun Foam

COD	Unid.	Unid.	€ x Unid.
16527	1	5	55,00

ESPUMA POLIURETANO

Pu foams



COD	ml.	BOTE	Unid.	€ x Unid.
1 805 CÁNULA	750	BOTE	12	13,00
2 805P PISTOLA	750	BOTE	12	13,00

Excelente capacidad de adhesión y llenado. Alto aislamiento térmico y acústico.
Excellent adhesion and filling capacity .High thermal & acoustical insulation.

ESPUMA ADHESIVA 60 SEGUNDOS

Fast adhesive foam within 60 seconds



COD	ml.	BOTE	Unid.	€ x Unid.
967P	750	BOTE	12	18,00

Espuma adhesión en 60 segundos para paneles de aislamiento térmico.
Fast adhesive foam in 60 seconds for thermal insulation boards.

ESPUMA THERMOCOAT

Thermocoat Foam



COD	ml.	BOTE	Unid.	€ x Unid.
TC	750	BOTE	12	18,50

Es una espuma de poliuretano que proporciona un aislamiento térmico y acústico de primera calidad en edificios y viviendas.
Thermocoat a thermal & acoustic Insulation Pu Spray Foam.

LIMPIADOR ESPUMA

Foam cleaner

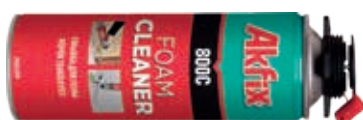

COD	ml.	BOTE	Unid.	€ x Unid.
800C	500	BOTE	12	17,00

Quita la espuma de pu fresca de los adaptadores de pistola después de la aplicación así como en todo tipo de superficies.
Removes fresh pu foam on gun adapters after application as well as on all kind of surfaces.



COLA BLANCA D3

Wood glue

COD	gr.		Unid. 	€ x Unid.
D3-500	500	BOTE	12	8,00

Cola blanca resistente al agua y secado rápido.
White glue, water resistant and fast curing.



ADHESIVO POLIUTERANO PARA MADERA D4

Pu wood glue

COD	gr.		Unid. 	€ x Unid.
PA370	560	BOTE	12	17,50

Adhesivo de poliuretano transparente de curado rápido de un componente. Alta resistencia al agua. Impermeable D4 según DIN EN204.
Transparent express curing polyurethane adhesive of one component. High water resistance. Water proof D4 according to DIN EN204.



LIMPIADOR DE CONTACTOS ELÉCTRICOS

Electrical contact cleaner

COD	ml.		Unid. 	€ x Unid.
A60	400	BOTE	12	15,00

Para eliminar grasa, suciedad, aceite en elementos eléctricos y electrónicos. Evapora rápidamente sin dejar residuos.
To eliminate grease, dirt, oil on electrical & electronic elements. Evaporate quickly leaving no residue.



SPRAY LIMPIADOR DE FRENOS

Brake cleaner spray

COD	ml.		Unid. 	€ x Unid.
A110	500	BOTE	12	9,00

Limpiador de frenos y embragues. Ayuda a los frenos a durar más y funcionar mejor.
Cleaner for brakes and clutches. It helps brakes to last longer and perform better.



SPRAY SILICONA

Silicone spray

COD	ml.		Unid. 	€ x Unid.
A80	400	BOTE	12	7,20

Agente desmoldeante y lubricante. Muestra un rendimiento perfecto incluso a altas temperaturas.
Silicone based mould release agent. It shows perfect performance even at high temperatures.



TOALLITAS INDUSTRIALES



QUÍMICO

TOALLITAS INDUSTRIALES

Industrial wipes

COD	Unid.		Unid. 	€ x Unid.
WIPESB	75	BOTE	6	18,00
WIPES	20	BOLSA	60	5,00

Limpieza de manos. Elimina aceite, grasa, pintura, tinta y adhesivos.

Hand cleaning. Removes oil, grease, paint, ink and adhesives.



MIXERS PARA RESINAS

Resin Mixers

COD	Ref.	Unid. 	Unid. 	€ x 100
16520	LPRMIX	10	200	90,00



BOMBA DE SOPLADO

Blow Pump

COD	Ref.	Unid. 	Unid. 	€ x Unid.
16525	LPBOM	1	5	25,00



PISTOLA RESINA 380ML. Y SILICONA

Resin and Silicone Gun

COD	Ref.	Unid. 	Unid. 	€ x Unid.
16500	LPP380	1	5	35,00
16510	LPPSIL	1	5	23,00
16515	LPP380PRO	1	5	141,50
16516	LPPSILPRO	1	5	117,95

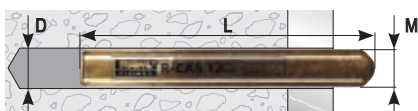

CÁPSULA QUÍMICA VINILESTER

Vinylester Spin in Capsule

COD	D mm	M mm	L mm	Unid. 	€ x 100
R-CAS-V-08	10	M8	75	10	190,00
R-CAS-V-10	12	M10	80	10	210,00
R-CAS-V-12	14	M12	95	10	220,00
R-CAS-V-16	18	M16	95	10	230,00
R-CAS-V-20	25	M20	175	6	525,00
R-CAS-V-24	28	M24	210	6	650,00
R-CAS-V-30	35	M30	270	2	1.200,00



RESINA POLIÉSTER 380 ML. + 2 MIXERS

Polyester Resin 380 ml. + 1 mixer

COD	Ref.	Unid. 	Unid. 	€ x Unid.
R-KF2-380	LPR380	1	10	14,00



RESINA VINILESTER 380 ML. + 2 MIXERS

Vinylester Resin 380 ml. + 2 mixer

COD	Ref.	Unid. 	Unid. 	€ x Unid.
R-KER-380	EPOXI 380	1	10	19,90



RESINA POLIÉSTER SIN ESTIRENO 300 ML. + 2 MIXERS

Polyester Styrene Free 300 ml. + 2 mixer

COD	Ref.	Unid. 	Unid. 	€ x Unid.
R-KEM-300	LPR300	1	10	14,50



RESINA VINILESTER 300 ML. + 2 MIXER

Vinylester Resin 300 ml. + 2 mixer

COD	Ref.	Unid. 	Unid. 	€ x Unid.
R-KER-300	Sin estireno	1	10	19,00



RESINA PURO EPOXI 400 ML. + 1 MIXER

Pure Epoxy Resin 400 ml. + 1 mixer

COD	Ref.	Unid. 	Unid. 	€ x Unid.
R-KEX-400	Puro Epoxi	1	10	43,00

**ESPÁRRAGO QUÍMICO HEXAGONAL
ZINCADO BLANCO**

Hex. Chemical Anchor Stud | White Plated



COD	↑mm.	Unid. 	€ x 100
R-STUDS-08110	M8×110	10	69,00
R-STUDS-08160	M8×160	10	80,00
R-STUDS-10130	M10×130	10	109,00
R-STUDS-10170	M10×170	10	132,00
R-STUDS-10190	M10×190	10	138,00
R-STUDS-12160	M12×160	10	172,00
R-STUDS-12190	M12×190	10	195,00
R-STUDS-12220	M12×220	10	348,00
R-STUDS-12260	M12×260	10	225,00
R-STUDS-12300	M12×300	5	275,00
R-STUDS-16190	M16×190	10	345,00
R-STUDS-16220	M16×220	10	395,00
R-STUDS-16260	M16×260	10	448,00
R-STUDS-16300	M16×300	5	500,00
R-STUDS-16380	M16×380	1	570,00
R-STUDS-20260	M20×260	5	690,00
R-STUDS-20300	M20×300	1	1.500,00
R-STUDS-30380	M30×380	1	2.175,00

**ESPÁRRAGO QUÍMICO HEXAGONAL
ACERO INOXIDABLE A4**

Hex. Chemical Anchor Stud | Stainless Steel A4

COD	↑mm.	Unid. 	€ x 100
R-STUDS-08110-A4	M8×110	10	425,00
R-STUDS-10130-A4	M10×130	10	750,00
R-STUDS-12160-A4	M12×160	10	1.150,00
R-STUDS-16190-A4	M16×190	10	2.350,00
R-STUDS-20260-A4	M20×260	5	4.600,00

TAMIZ NYLON

Nylon Sleeve

COD	Ref.		Unid. 	Unid. 	€ x 100
16200	12	50	10	240	45,00
16201	16	85	10	240	40,00
16202	20	85	10	120	61,00

TAMIZ HEMBRA

Metal Sleeve

COD	Ref.		Unid. 	Unid. 	€ x 100
16210	8	80	10	240	250,00
16211	10	80	10	240	340,00
16212	12	80	10	240	400,00



ADHESIVO PVC S20 PRESIÓN SECADO RÁPIDO

Fast Curing S20 PVC Adhesive

COD	i	ml.	BOTE	Unid.	€ x Unid.
N40-125	con pincel	125	BOTE	25	3,75
N40-250	con pincel	250	BOTE	24	9.90
N40-500	con pincel	500	BOTE	24	14,25
N40-1000	con pincel	1000	BOTE	12	21,50



DESATASCADOR PROFESIONAL

Professional Drain Cleaner

COD	ml.	BOTE	Unid.	Unid.	€ x Unid.
HP00055	500	BOTE	1	12	10,35
HP00056	1.000	BOTE	1	6	17,00



GEL DE MANOS HIDROALCOHÓLOCO

Hydroalcoholic Hand Sanitizer

COD	ml.	BOTE	Unid.	€ x Unid.
TGM03	100	BOTE	100	4,75
TGM04	500	BOTE	42	10,00
TGM05	1.000	BOTE	20	17,25
TGM06	5.000	GARRAFA	4	58,50



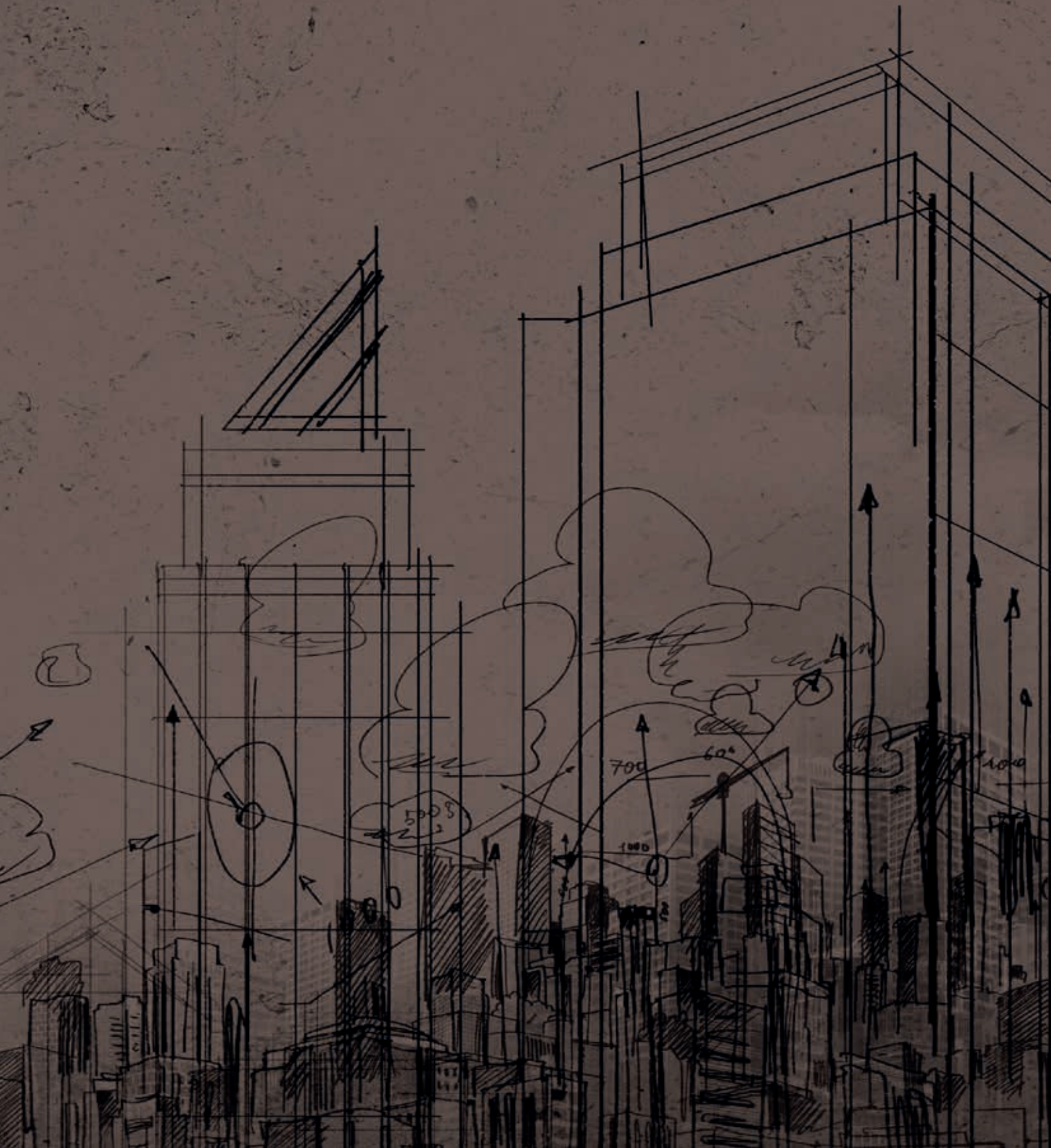

8

TORNILLERÍA Y ACCESORIOS

Screws and Accessories

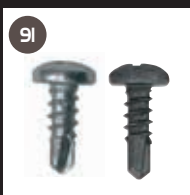
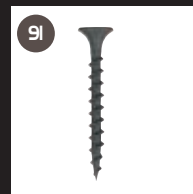
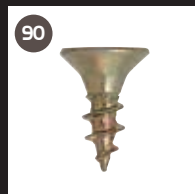
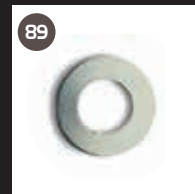
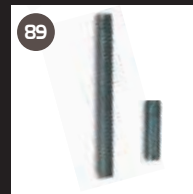
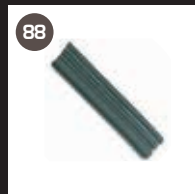
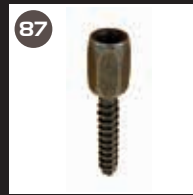
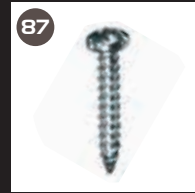



TAPA-ENCHUFES DE SEGURIDAD

Wall Plug Safety Covers

COD		Unid. 	Unid. 	€ x 100
2000		25	2.500	8,26
2100		100	3.000	8,50



TAPA-TORNILLOS

Screw Head Covers

COD RAL 9003	COD RAL 7035	COD RAL 9005	Unid. 	Unid. 	€ x 100
2010	2011	2012	100	20.000	4,55
2020	2021	2022	1.000	20.000	4,11

SOPORTES FIJOS

Fixed Supports

COD	mm. 	Unid. 	Unid. 	€ x 100
7050	55	250	250	128,38
7051	75	250	250	136,07
7051-AL	Alum 75	250	250	136,07
7052	95	200	200	146,38

SOPORTES REGULABLES

Adjustable Supports





COD	mm. 	Unid. 	Unid. 	€ x 100
1. 7053	75	100	100	238,14
2. 7054	75	200	200	293,37







TORNILLOS PARA GRAPAS Y ABRAZADERAS

Clips and Clamps Screws

COD			Unid. 	Unid. 	€ x 100
12107	4x20 mm	8 mm	100	6.000	5,25
* 12100	5x25 mm	10 mm	100	6.000	6,40
* 12101	5x30 mm	10 mm	100	6.000	8,80
12102	4,5x35 mm	8 mm	100	6.000	6,90
12103	4x45 mm	8 mm	100	6.000	6,90
12105	3,5x45 mm	7 mm	100	6.000	6,53
12106	3,5x30 mm	7 mm	100	6.000	5,12
12108	6x45 mm	10 mm	100	3.000	9,50



TORNILLOS TIRAFONDOS M-6 Y M-8

M-6 and M-8 Screws

COD		Unid. 	Unid. 	€ x 100
12000	M6x30 mm	100	6.000	4,80
12001	M6x40 mm	100	6.000	5,75
12002	M6x50 mm	100	3.000	6,91
12003	M8x40 mm	100	3.000	10,00
12004	M8x60 mm	100	3.000	12,00

ESPÁRRAGOS DOBLE ROSCA



Double Threaded Screws

COD		Unid. 	Unid. 	€ x 100
7082	M-8x60 mm	100	1.200	19,97
7083	M-8x80 mm	100	1.200	21,41
7084	M-8x90 mm	100	1.200	22,93
7085	M-8x100 mm	100	1.200	24,37
7086	M-10x90 mm	100	1.200	32,42
7087	M-10x100 mm	50	600	36,97
7088	M-10x110 mm	50	600	44,58



TORNILLO HEMBRA HORMIGÓN

M-6 and M-8 Screws for Concrete



COD		Unid. 	Unid. 	€ x 100
7130	M6x34 mm	100	1.200	67,00
7131	M8x34 mm	100	1.200	68,00





MANGUITOS CILÍNDRICOS



Cylindrical Metallic Couplings

COD		Unid. 	Unid. 	€ x 100
7025	M-6x20 mm	200	6.000	20,93
7026	M-6x30 mm	200	6.000	27,42
7027	M-8x30 mm	100	3.000	30,00



MANGUITOS HEXAGONALES

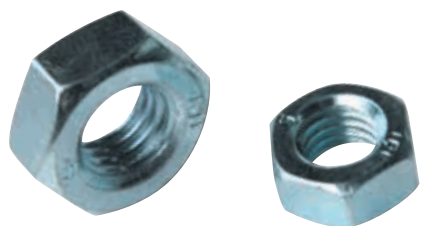

Hexagonal Metallic Couplings

COD		Unid. 	Unid. 	€ x 100
7020	M-6x20 mm	100	6.000	22,23
7021	M-6x30 mm	100	3.000	29,64
7022	M-8x30 mm	100	3.000	34,08
7023	M-10x30 mm	50	1.500	44,45
7024	M-12x30 mm	25	750	80,01



TUERCAS HEXAGONALES DIN 934



Hexagonal Nuts DIN 934

COD		Unid. 	Unid. 	€ x 100
7034	M-4	200	12.000	1,41
7035	M-5	200	12.000	1,76
7030	M-6	200	12.000	2,11
7031	M-8	200	12.000	7,00
7032	M-10	100	6.000	9,95



PERFIL DE CAUCHO

Rubber Profile



COD		Unid. 	Unid. 	€ x 100
22720	20x3	10	300	450,00



NOVEDAD

MORDAZA VIGA CHAPA

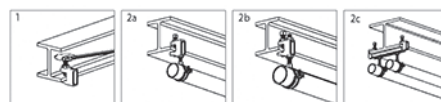

Beam clamp

COD		Unid. 	Unid. 	€ x 100
7141	M-8	100	100	250,00
7142	M-10	50	50	325,00





VARILLAS ROSCADAS DIN 975

Threaded Rods DIN 975

COD			€ x 100
7004	M-4x1000 mm	100	92,93
7005	M-5x1000 mm	100	110,25
7000	M-6x1000 mm	100	113,40
7001	M-8x1000 mm	50	196,88
7002	M-10x1000 mm	25	308,70
7003	M-12x1000 mm	20	450,00



ESPÁRRAGOS SEPARADORES DIN 976

Threaded Nipples DIN 976

COD		Unid. 	Unid. 	€ x 100
7010	M-6x20 mm	200	12.000	5,86
7011	M-6x30 mm	200	12.000	7,90
7012	M-8x20 mm	200	12.000	9,34
7013	M-8x30 mm	200	6.000	13,50



ARANDELAS DIN 125

Washers DIN 125

COD		Unid. 	Unid. 	€ x 100
7044	M-4	200	12.000	1,02
7045	M-5	200	12.000	1,06
7040	M-6	200	12.000	1,90
7041	M-8	200	12.000	2,95
7042	M-10	200	12.000	3,87



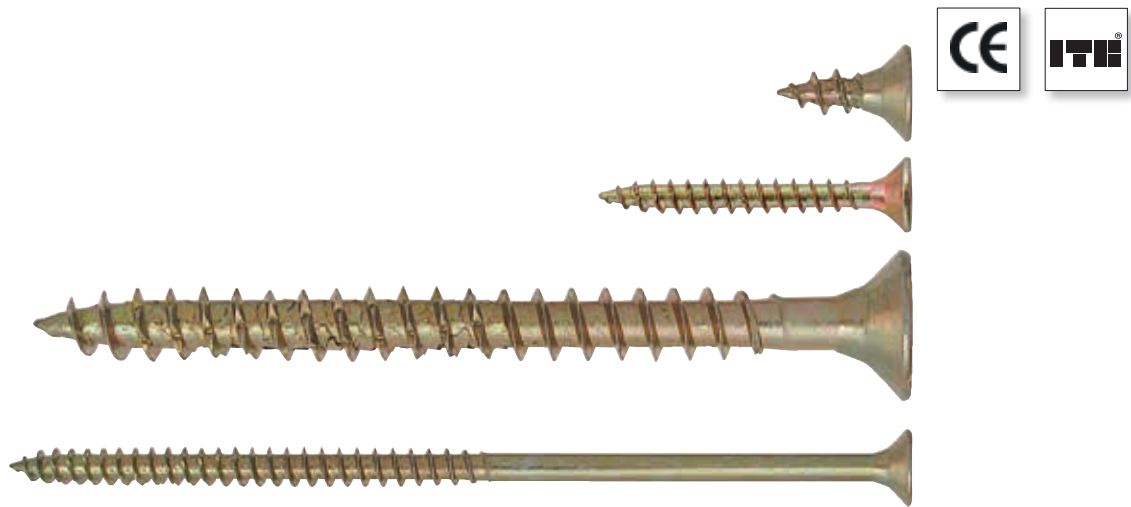

ARANDELAS DIN 9021

Washers DIN 9021

COD		Unid. 	Unid. 	€ x 100
7111	M-5	200	12.000	1,25
7112	M-6	200	12.000	2,85
7113	M-8	200	12.000	5,95
7114	M-10	200	12.000	11,65





**TORNILLOS POZIDRIV
BICROMATADOS**

Pozidriv Screws Yellow Zinc Plated

COD			Unid. 	Unid. 	€ x 100	
UC-3012	3.0×12	PZ1	●	1.000	24.000	1,10
UC-3016	3.0×16	PZ1	●	1.000	24.000	1,20
UC-3020	3.0×20	PZ1	●	1.000	24.000	1,29
UC-3025	3.0×25	PZ1	●	1.000	18.000	1,31
UC-3030	3.0×30	PZ1	●	1.000	18.000	1,69
UC-3035	3.0×35	PZ1	●	1.000	18.000	1,77
UC-3040	3.0×40	PZ1	●	1.000	12.000	2,02
UC-3512	3.5×12	PZ2	●	1.000	24.000	1,15
UC-3516	3.5×16	PZ2	●	1.000	24.000	1,26
UC-3520	3.5×20	PZ2	●	1.000	18.000	1,43
UC-3525	3.5×25	PZ2	●	1.000	18.000	1,63
UC-3530	3.5×30	PZ2	●	1.000	18.000	1,85
UC-3535	3.5×35	PZ2	●	1.000	12.000	2,16
UC-3540	3.5×40	PZ2	●	1.000	12.000	2,36
UC-3545	3.5×45	PZ2	●	500	9.000	2,60
UC-3550	3.5×50	PZ2	●	500	6.000	3,15
UC-4016	4.0×16	PZ2	●	1.000	18.000	1,53
UC-4020	4.0×20	PZ2	●	1.000	18.000	1,76
UC-4025	4.0×25	PZ2	●	1.000	18.000	2,04
UC-4030	4.0×30	PZ2	●	500	9.000	2,31
UC-4035	4.0×35	PZ2	●	500	9.000	2,66
UC-4040	4.0×40	PZ2	●	500	9.000	2,88
UC-4045	4.0×45	PZ2	●	500	9.000	3,33
UC-4050	4.0×50	PZ2	●	500	6.000	3,61
UC-4060	4.0×60	PZ2	●	500	6.000	4,21
UC-4070	4.0×70	PZ2	▸	250	3.000	4,98
UC-4080	4.0×80	PZ2	▸	100	1.800	6,70
UC-4530	4.5×30	PZ2	●	500	9.000	3,40
UC-4535	4.5×35	PZ2	●	500	9.000	3,41
UC-4540	4.5×40	PZ2	●	250	4.500	3,50
UC-4545	4.5×45	PZ2	●	250	4.500	4,03
UC-4550	4.5×50	PZ2	●	250	4.500	4,95

**TORNILLOS POZIDRIV
BICROMATADOS**

Pozidriv Screws Yellow Zinc Plated

COD			Unid. 	Unid. 	€ x 100	
UC-4560	4.5×60	PZ2	●	250	3.000	5,00
UC-4570	4.5×70	PZ2	▸	250	3.000	6,24
UC-4580	4.5×80	PZ2	▸	100	1.800	8,50
UC-5020	5.0×20	PZ2	●	500	9.000	2,73
UC-5025	5.0×25	PZ2	●	500	9.000	3,25
UC-5030	5.0×30	PZ2	●	500	9.000	3,52
UC-5035	5.0×35	PZ2	●	500	9.000	4,50
UC-5040	5.0×40	PZ2	●	250	4.500	4,49
UC-5045	5.0×45	PZ2	●	250	4.500	4,96
UC-5050	5.0×50	PZ2	●	200	3.600	5,38
UC-5060	5.0×60	PZ2	●	200	2.400	6,45
UC-5070	5.0×70	PZ2	▸	200	2.400	7,38
UC-5080	5.0×80	PZ2	▸	100	1.800	8,75
UC-5090	5.0×90	PZ2	▸	100	1.200	10,56
UC-5100	5.0×100	PZ2	▸	100	1.200	12,10
UC-5120	5.0×120	PZ2	▸	100	1.200	19,34
UC-6030	6.0×30	PZ3	●	200	3.600	5,59
UC-6040	6.0×40	PZ3	●	200	3.600	6,72
UC-6050	6.0×50	PZ3	●	200	3.600	8,11
UC-6060	6.0×60	PZ3	●	200	2.400	9,44
UC-6070	6.0×70	PZ3	▸	100	1.200	10,90
UC-6080	6.0×80	PZ3	▸	100	1.200	12,51
UC-6090	6.0×90	PZ3	▸	100	1.200	14,70
UC-6100	6.0×100	PZ3	▸	100	1.200	16,98
UC-6110	6.0×110	PZ3	▸	100	1.200	19,03
UC-6120	6.0×120	PZ3	▸	100	1.200	21,58
UC-6130	6.0×130	PZ3	▸	100	1.200	29,21
UC-6140	6.0×140	PZ3	▸	100	1.200	32,87
UC-6150	6.0×150	PZ3	▸	100	1.200	30,99
UC-6160	6.0×160	PZ3	▸	100	1.200	37,60
UC-6180	6.0×180	PZ3	▸	100	1.200	58,94
UC-6200	6.0×200	PZ3	▸	100	1.200	69,44

● Toda la rosca / Full Thread

▸ Media rosca / Partial Thread





**TORNILLOS FOSFATADOS PARA PLADUR
PARA METAL**

Drywall Screws for Metal

COD		Unid. 	Unid. 	€ x 100
FS-3525	3.5×25	1.000	24.000	1,45
FS-3535	3.5×35	1.000	12.000	1,92
FS-3545	3.5×45	500	6.000	2,50
FS-4270	4.2×70	250	3.000	4,50
FS-4890	4.8×90	250	3.000	10,00
FS-48100	4.8×100	200	2.400	14,50
FS-48110	4.8×110	200	2.400	15,85
FS-48120	4.8×120	200	2.400	20,00



**TORNILLOS FOSFATADOS PARA PLADUR
PARA MADERA**

Drywall Screws for Wood

COD		Unid. 	Unid. 	€ x 100
FT-3525	3.5×25	1.000	24.000	1,43
FT-3535	3.5×35	1.000	12.000	1,92
FT-3545	3.5×45	500	6.000	2,48
FT-3555	3.5×55	500	6.000	3,00
FT-4270	4.2×70	250	3.000	4,50
FT-4890	4.8×90	250	3.000	9,00
FT-48100	4.8×100	200	2.400	13,10
FT-48110	4.8×110	200	2.400	14,30
FT-48120	4.8×120	200	2.400	18,00



**TORNILLOS FOSFATADOS AUTOTALADRANATES
PARA PLADUR**

Drilling Drywall Screws

COD		Unid. 	Unid. 	€ x 100
WS-3525	3.5×25	1.000	24.000	2,05
WS-3535	3.5×35	1.000	12.000	2,40
WS-3545	3.5×45	500	6.000	2,85



TORNILLOS AUTOTALADRANTES

Drilling Drywall Screws

COD		Unid. 	Unid. 	€ x 100
Fosfatado Negro de Acero Bajo en Carbono Black Phosphate Low Carbon Steel				
1. WS-3595	3.5×9.5	1.000	24.000	1,50
2. WS-3595-OC	3.5×9.5	1.000	24.000	1,50
Bajo Carbono, Zincado Blanco min. 6 micras Low Carbon, Zinc Plated Steel min. 6 micras				
3. WS-3911	3.9×11	1.000	24.000	1,85
4. WS-3911-OC	3.9×11	1.000	24.000	1,85

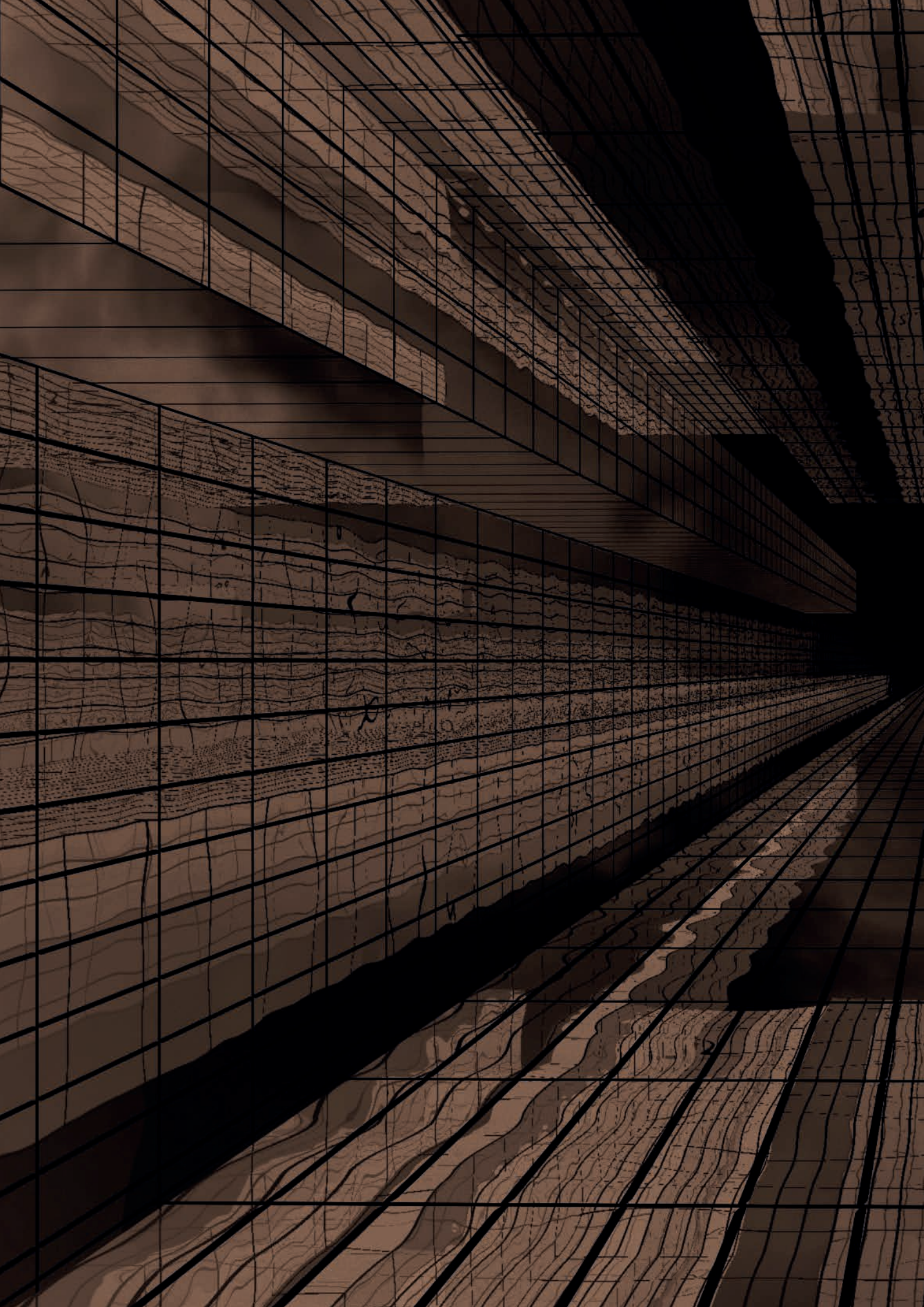

9

MÁQUINA DE GAS Y SOLDADURA

Gas Nailers & welding

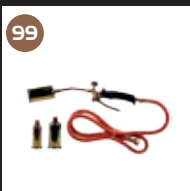
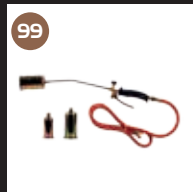
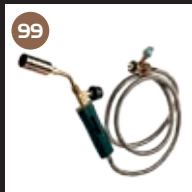
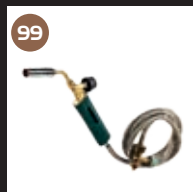
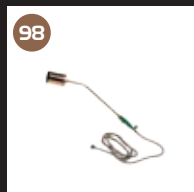
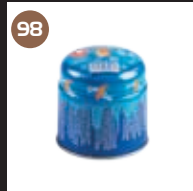
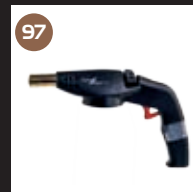
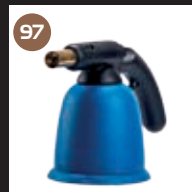
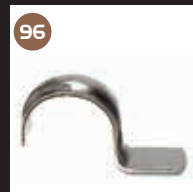
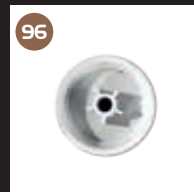
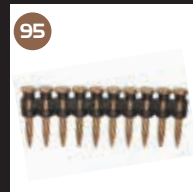
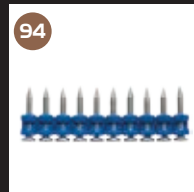



PISTOLA CLAVAGAS



Clavagas Gas Nailer

COD		Unid. 	€ x Unid.
R-RAWL-SC40II	Maleta/Suitcase	1	1.700,00



CLAVOS GAS SC40 II

Nails SC40 II

COD	Ref.	Unid. 	Unid. 	€ x 100
R-KNC-6/17/500	CLAVOGAS SC40 II 17 MM. HORMIGÓN/CONCRETE	500	5.000	23,00
R-KNC-6/19/500	CLAVOGAS SC40 II 19 MM. HORMIGÓN/CONCRETE	500	5.000	23,00
R-KNC-6/22/500	CLAVOGAS SC40 II 22 MM. HORMIGÓN/CONCRETE	500	5.000	23,00
R-KNC-6/25/500	CLAVOGAS SC40 II 25 MM. HORMIGÓN/CONCRETE	500	5.000	23,25
R-KNC-6/27/500	CLAVOGAS SC40 II 27 MM. HORMIGÓN/CONCRETE	500	5.000	23,45
R-KNC-6/32/500	CLAVOGAS SC40 II 32 MM. HORMIGÓN/CONCRETE	500	5.000	23,57
R-KNC-6/38/500	CLAVOGAS SC40 II 38 MM. HORMIGÓN/CONCRETE	500	5.000	23,93
R-KSC-6/17/500	CLAVOGAS SC40 II 17 MM. HIERRO/STEEL	500	5.000	23,00
R-KSC-6/19/500	CLAVOGAS SC40 II 19 MM. HIERRO/STEEL	500	5.000	23,00

GAS





CLAVOS GAS 1.000

Nails 1.000

COD	Ref.	Unid.	Unid.	€ x 100
24510	CLAVOGAS 1000/15 mm.	1.000	10.000	23,00
24511	CLAVOGAS 1000/20 mm.	1.000	10.000	23,00
24512	CLAVOGAS 1000/25 mm.	1.000	10.000	23,25
24513	CLAVOGAS 1000/30 mm.	1.000	10.000	23,45
24515	CLAVOGAS 1000/40 mm.	1.000	10.000	23,93
24516	CLAVOGAS 1000/50 mm.	1.000	10.000	29,00
24517	CLAVOGAS 1000/60 mm.	1.000	10.000	29,50



CLAVOS GAS 700

Nails 700

COD	Ref.	Unid.	Unid.	€ x 100
24540	CLAVOGAS 700/15 mm.	1.000	10.000	25,67
24541	CLAVOGAS 700/20 mm.	1.000	10.000	23,00
24542	CLAVOGAS 700/25 mm.	1.000	10.000	23,25
24543	CLAVOGAS 700/30 mm.	1.000	10.000	23,45
24545	CLAVOGAS 700/40 mm.	1.000	10.000	23,93



CLAVO MÉTRICO M6

M6 Metric Nails

COD	∅ mm.	Unid.	Unid.	€ x 100
24520	M6x25	1.000	10.000	40,000



GAS

Fuel Cell

	COD	Ref.	Unid.	Unid.	€ x Unid.
1.	24504	700	1	12	35,00
2.	24505	1.000	1	12	35,00



ABRAZADERAS LPX

Lpx Clamps

COD RAL 7035	∅ mm.	Unid. x	Unid. x	€ x 100
25501	15-18	100	400	33,00
25502	20-25	50	200	40,00
25503	25-32	50	200	48,00

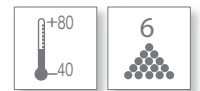

BASE BRIDA DISPARO

Tie Bases

COD RAL 7035	COD RAL 9005	x.max.	Unid. x	Unid. x	€ x 100
25520	25521	10 mm.	100	2.400	9,91



ARANDELA DISPARO

Washers

COD RAL 7035	∅ mm.	Unid. x	Unid. x	€ x 100
24532	20	100	5.000	9,91



GRAPAS UNA PATA DISPARO

Single Foot Clips

COD	∅ mm.	Unid. x	Unid. x	€ x 100
9056	16	100	3.000	8,29
9057	18	100	1.200	8,87
9058	20	100	1.200	11,32
9059	22	100	1.200	12,14
9060	25	100	1.200	13,30
9062	28	100	600	15,17
9064	32	100	600	21,12



SOPLETE TORNADO

Blow Torch

COD	Unid.	Unid.	€ xUnid.
CO23PIEZO	1	6	42,86

Base dotada de sistema de seguridad patentado antibloqueo, empuñadura soft touch de goma, llama y punta profesional.

Base with patented safety system against cartridge unlocking. Rubber handgrip and professional point flame.



CABEZAL SOLDADURA SUPERGAS

Super Gas Blow Torch

COD	Unid.	Unid.	€ xUnid.
1060	1	6	45,00

Cabezal soldador con empuñadura ergonómica, llama constante. Apto para todos los cartuchos con válvula 7/16".

Blow torch with ergonomic handle and constant flame. Suitable for all cartridge with 7/16" threaded valve.



SOLDADOR CON CARTUCHO

Blow Torch with Cartridge

COD			Unid.	Unid.	€ xUnid.
1047	600 ml.	330 gr.	1	6	45,00

Soldador equipado con cartucho de 600ml (art.575), con 30% Propano/ 70% Butano) apto para todos los cartucho con válvula 7/16".

Blow torch kit ready to use with cartridge supergas code 575. It contains a special mixture of 30% propane; 70% Butane. To be used with 7/16" valve cartridges.



SUPERGAS

Supergas

COD			Unid.	€ xUnid.
575	600 ml.	330 gr.	12	8,00

SUPERGAS con válvula de seguridad roscada externa 7/16; Contiene 30% Propano; 70% Butano.

SUPERGAS with external 7/16" threaded safety valve. It contains a special mixture of 30% propane; 70% Butane.



CARTUCHO PERFORABLE

Butane Piercing Cartridge

COD		Unid.	€ xUnid.
1120	190 gr.	36	3,00

Cartucho Perforable 190gr con valvula de seguridad. "Stop Gas System" bloquea la salida del gas en caso de desenroscamiento. **Cumple con EN 417.**

Butane piercing 190gr cartridge with safety system. "Stop Gas System". **Complying with EN 417.**



CARTUCHO RECARGA

Cartridge to Refill

COD		Unid.	€ xUnid.
10051	90 gr.	20	4,75

Cartucho de gas para la recarga de encendedores y microsoldadores con 6 adaptadores diversos. Cartridge to refill lighters and microsoldering torches. Equipped with 6 diferents adapters.



REGULADOR PRESIÓN SALIDA 28-30 mbar.

Gas regulator 28-30mbar

COD	Unid.	Unid.	€ xUnid.
200072	1	6	17,00



REGULADOR SALIDA LIBRE

Free output regulator

COD	Unid.	Unid.	€ xUnid.
200084	1	6	21,20



CONJUNTO CHAMUSCADOR

Welding Torch Kit

COD	Unid.	Unid.	€ xUnid.
240157	1	6	52,00

Conjunto chamuscador alta potencia G.L.P. con manguera blindada 3m + boquilla ø 70mm. Potencia 40000 Kcal/h.

Hight power torch with 3 meters hose + ø 70mm nozzle Power 40000Kcal/h

GAS





SOLDADOR CON MANGUERA Ø 30

Welding Kit with gas hose

COD	Unid.	Unid.	€ xUnid.
240040	1	6	55,00

Soldador con manguera, grifo y boquilla 3600 Kcal/h. Kit compuesto por manguera blindada 1,5m + grifo adaptable a botella popular (azul o naranja) + boquilla Ø 20mm.

Welding Kit with gas hose, tap and nozzle 8400 Kcal/h; 1,5m gas hose + tap adaptable to popular bottle (blue or orange) + Ø30mm nozzle.



SOLDADOR CON MANGUERA Ø 20

Welding Kit with gas hose

COD	Unid.	Unid.	€ xUnid.
240041	1	6	57,50

Soldador con manguera, grifo y boquilla 8400 Kcal/h. Kit compuesto por manguera blindada 1,5m + grifo adaptable a botella popular (azul o naranja) + boquilla Ø 30mm.

Welding Kit with gas hose, tap and nozzle 8400 Kcal/h; 1,5m gas hose + tap adaptable to popular bottle (blue or orange) + Ø20mm nozzle.



KIT SOPLETE BOQUILLAS

Welding torch Kit with 3 nozzles

COD	Unid.	Unid.	€ xUnid.
CO22-0130	1	6	60,00

BOQUILLA 35MM 6,3 KW (5420 KCAL/H)	NOZZLE 35MM Ø 6,3 KW (5420 KCAL/H)
BOQUILLA 45MM 19,5 KW (16770 KCAL/H)	NOZZLE 45MM Ø 19,5 KW (16770 KCAL/H)
BOQUILLA 60MM 35 KW (30100 KCAL/H)	NOZZLE 605MM Ø 6,3 KW (5420 KCAL/H)

Kit soplete 3 boquillas y empuñadura con gatillo de regulación y tubo de gas 1,5m.

Funciona con gas butano o propano. Presión de trabajo directa.

Kit including welding torch with 3 nozzles & handgrip with regular and 1,5m gas hose.

Works with butane or propane. Direct working pressure.



KIT SOPLETE BOQUILLAS

Welding torch Kit with 3 nozzles

COD	Unid.	Unid.	€ xUnid.
CO22-0137	1	6	56,00

BOQUILLA 25MM 3,7 KW (3180 KCAL/H)	NOZZLE 25MM Ø 3,7 KW (3180 KCAL/H)
BOQUILLA 35MM 6,3 KW (5420 KCAL/H)	NOZZLE 35MM Ø 6,3 KW (5420 KCAL/H)
BOQUILLA 50MM 28 KW (24080 KCAL/H)	NOZZLE 50MM Ø 28 KW (24080 KCAL/H)

Kit soplete 3 boquillas y empuñadura con gatillo de regulación y tubo de gas 1,5m.

Funciona con gas butano o propano. Presión de trabajo directa.

Kit including welding torch with 3 nozzles & handgrip with regular and 1,5m gas hose.

Works with butane or propane. Direct working pressure.



TACOS DE NYLON
COD. 3904 Ø 14 x 30 mm
12 unidades
Para Tornillo de Ø 8 x 3 mm

TACOS DE NYLON
COD. 3904 Ø 14 x 30 mm
6 unidades
Para Tornillo de Ø 8 x 3 mm

TACOS DE NYLON
COD. 3908 Ø 10 x 30 mm
4 unidades
Para Tornillo de Ø 6 x 3 mm

TACOS LP4 NYLON
COD. 3940 Ø 6 x 25 mm
54 unidades
Para Tornillo de Ø 3 x 4 mm

TACOS NYLON + TIRAFONDO
COD. 3936 Ø 8 x 30 mm
6 unidades

TACOS NYLON + TIRAFONDO
COD. 3936 Ø 8 x 30 mm
6 unidades

TACOS LP4 + TIRAFONDO
COD. 3944 Ø 8 x 40 mm
6 unidades
Para Tornillo de Ø 3 x 4 mm

TACOS LP4 + POZIDRIV
COD. 3943 Ø 10 x 50 mm
6 unidades
Para Tornillo de Ø 3 x 4 mm

TACOS NYLON Ø 10 x 30 mm

TACOS NYLON Ø 10 x 30 mm

TACOS NYLON Ø 10 x 30 mm

TACOS NYLON Ø 10 x 30 mm

ABRAZ. CIERRE NYLON
COD. 3901 Ø 23 mm
6 unidades

ABRAZ. CIERRE NYLON
COD. 3901 Ø 15 mm
6 unidades

ABRAZ. CIERRE NYLON
COD. 3901 Ø 16 mm
6 unidades

ABRAZ. CIERRE NYLON
COD. 3901 Ø 18 mm
6 unidades

ABRAZ. CIERRE NYLON
COD. 3901 Ø 20 mm
6 unidades



BLISTERS



LAPAFIL

BLISTERS



TACOS NYLON

NYLON PLUGS

COD	mm.	Unid.	Unid.	€
3300	4X20	24	30	2,00
3301	5X25	24	30	2,00
3302	6x30	12	30	2,00
3304	8x40	6	30	2,00
3305	10x50	4	30	2,00



TACOS NYLON LP4

NYLON PLUGS LP4

COD	mm.	Unid.	Unid.	€
3930	5X25	24	30	2,20
3931	6x30	12	30	2,20
3932	8x40	6	30	2,20
3933	10x50	4	30	2,20

TACOS NYLON + POZIDRIV

NYLON PLUGS + POZIDRIV

COD	mm.	mm.	Unid.	Unid.	€
3330	5X25	4X30	12	30	2,50
3331	6X30	4,5x35	12	30	2,50
3332	8X40	5x40	6	30	2,50
3333	10X50	6x60	4	30	2,50







TACOS NYLON + TORNILLO TIRAFONDO

NYLON PLUGS + LAG SCREW

COD	mm.	mm.	Unid.	Unid.	€
3325	6X30	M6X30	12	30	2,70
3326	8X40	M8X40	6	30	2,70

TACOS NYLON LP4 + POZIDRIV





NYLON PLUGS LP4 + POZIDRIV

COD	 mm.	 mm.	Unid. 	Unid. 	€ 
3940	5X25	4X30	12	30	2,60
3941	6X30	4,5x40	12	30	2,60
3942	8X40	5x50	6	30	2,60
3943	10X50	6x60	4	30	2,60







TACOS NYLON LP4 + TORNILLO TIRAFONDO

NYLON PLUGS LP4 + LAG SCREW

COD	 mm.	 mm.	Unid. 	Unid. 	€ 
3945	6X30	M6X40	12	30	2,80
3946	8X40	M8X60	6	30	2,80

TACOS NYLON LP4 + TORNILLO





NYLON PLUGS LP4 + SCREW

COD	 mm.	 mm.	Unid. 	Unid. 	€ 
3950	6X30	4,5X35	12	30	2,75
3951	8X40	6X45	6	30	2,75







TORNILLOS TIRAFONDOS

LAG SCREWS

COD	 mm.	Unid. 	Unid. 	€ 
12010	M6X30	12	30	2,75
12011	M6X40	12	30	2,75
12012	M8X40	6	30	2,75
12013	M8X60	6	30	2,75

TORNILLOS GRAPAS





CLIPS SCREWS

COD	 mm.	Unid. 	Unid. 	€ 
12020	5X25	12	30	2,85
12021	5X35	12	30	2,85
12022	4,5x35	12	30	2,85







GANCHOS BASCULANTES

GRAVITY TOGGLES

COD		Unid. 	Unid. 	€ 
8010	M4	2	20	3,00
8011	M5	2	20	3,00

ESPIGAS BASCULANTES





GRAVITY TOGGLES SPIKE

COD		Unid. 	Unid. 	€ 
8015	M4	2	20	3,00
8016	M5	2	20	3,00



GANCHOS DE ARPÓN





HARPOON TOGGLES

COD		Unid. 	Unid. 	€ 
8020	M4	2	20	3,00
8021	M5	2	12	3,00



ESPIGAS DE ARPÓN

SPIKE TOGGLES

COD		Unid. 	Unid. 	€ 
8023	M4	2	20	3,00
8024	M5	2	12	3,00

TAPA - ENCHUFES





WALL PLUG SAFETY COVERS

COD	Unid. 	Unid. 	€ 
2200	10	30	2,00







TACOS ACERO CON ARO

SLEEVE ANCHOR WITH EYE

COD	Ref.	mm. 		Unid. 	Unid. 	€ 
15930	LPA08	M6X45	8	4	20	2,71
15932	LPA10	M8X60	10	4	12	4,73
15934	LPA12	M10X70	12	4	8	7,73

TACOS ACERO CON GANCHO

SLEEVE ANCHOR WITH HOOK

COD	Ref.	mm. 		Unid. 	Unid. 	€ 
15920	LPG08	M6X45	8	4	20	2,71
15922	LPG10	M8X60	10	4	12	4,73
15924	LPG12	M10X70	12	4	8	7,73



ANCLAJE INOX CON TORNILLO





SLEEVE ANCHOR IN STAINLESS STEEL

COD	Ref.	mm.		Unid. 	Unid. 	€ 
15950	LPTIX08C	M6X45	8	4	20	4,76
15951	LPTIX08L	M6X60	8	4	20	5,00
15954	LPTIX10C	M8X60	10	4	20	7,45
15955	LPTIX10L	M8X80	10	4	20	8,45
15958	LPTIX12C	M10X70	12	4	12	11,25
15959	LPTIX12L	M10X100	12	4	8	16,04







TACOS ACERO CON TORNILLO 6.8





6.8 SLEEVE ANCHOR

COD	Ref.	mm.		Unid. 	Unid. 	€ 
15900	LPT08C	M6X45	8	4	20	1,92
15901	LPT08L	M6X60	8	4	20	2,07
15902	LPT09C	M6X45	9	4	20	1,99
15903	LPT09L	M6X60	9	4	20	2,14
15904	LPT10C	M8X60	10	4	20	2,91
15905	LPT10L	M8X80	10	4	20	3,22
15906	LPT11C	M8X60	11	4	20	3,02
15907	LPT11L	M8X80	11	4	20	3,35
15908	LPT12C	M10X70	12	4	12	4,02
15909	LPT12L	M10X100	12	4	8	4,62
15910	LPT14C	M10X70	14	4	12	4,47
15911	LPT14L	M10X100	14	4	8	5,23

GRAPAS EN BLISTER

CLIPS IN BLISTER

COD RAL 9003	COD RAL 9005	Ref.	↑mm.	mm. ² 		Unid. 	€ 
CABLE PLANO / FLAT CABLE							
1400	-	0	paralelo	2x0,7-2x1	20	30	2,00
1401	-	01	4x2	2x0,7	20	30	2,00
1402	-	02	paralelo	2x0,7-2x1	20	30	2,00
1403	-	03	6x2	2x1-3x0,7	20	30	2,00
1404	-	1	6,5x3	2x1	15	30	2,00
1405	-	2	7,5x3,5	2x1,5-3x1	15	30	2,00
1406	-	3	10x3,5	3x1,5-3x2,5	12	30	2,00

COD RAL 9003	COD RAL 9005	Ref.	∅mm.	mm. ² 	Unid. 	Unid. 	€ 
CABLE REDONDO / ROUND CABLE							
1407	1420	4	4	1x1-2x0,5	15	30	2,00
1408	1421	5	5	2x0,75	15	30	2,00
1409	1422	6	6	2x1	13	30	2,00
1410	1423	7	7	2x1-2x1,5	12	30	2,00
1411	1424	8	8	2x2,5	10	30	2,00
1412	1425	9	9	3x2,5	10	30	2,00
1413	1426	10	10	2x4	8	30	2,00
1513 (Natural)	TV	7		coaxial	8	30	2,00





II

ACCESORIOS

ACCESSORIES





DISCOS DE CORTE PARA INOX

Saw Blades for Stainless Steel

COD	∅ mm.	Unid. 	Unid. 	€ x 100
MN-68-911	115x1x22,23	25	500	180,00
MN-68-912	125x1x22,23	25	500	200,00
MN-68-913	180x1,6x22,23	25	500	460,00
MN-68-915	230x1,9x22,23	25	500	490,00
MN-68-916	115x1,6x22,23	25	500	255,00
MN-68-917	125x1,6x22,23	25	500	265,00

DISCOS DE CORTE PARA HIERRO

Saw Blades for Iron

COD	∅ mm.	Unid. 	Unid. 	€ x 100
MN-68-901	115x3x22,23	25	200	230,00
MN-68-902	125x3x22,23	25	200	250,00
MN-68-903	180x3x22,23	25	100	450,00
MN-68-905	230x3x22,23	25	50	480,00

DISCOS DE DESBASTE PARA HIERRO

Saw Blades for Iron Slab

COD	∅ mm.	Unid. 	Unid. 	€ x 100
MN-68-921	115x6x22,23	25	100	380,00
MN-68-922	125x6x22,23	25	100	390,00
MN-68-923	180x6x22,23	25	50	750,00
MN-68-925	230x6x22,23	25	50	1.150,00

DISCOS LÁMINAS PARA LIJAR

Sanding Discs

COD	∅ mm.	Unid. 	Unid. 	€ x 100
MN-68-811	115 GRANO 40	10	100	500,00
MN-68-812	115 GRANO 60	10	100	500,00
MN-68-813	115 GRANO 80	10	100	500,00
MN-68-814	115 GRANO 100	10	100	500,00
MN-68-815	115 GRANO 120	10	100	500,00



DISCOS DE CORTE PARA HORMIGÓN

Saw Blades for Concrete

COD	∅ mm.	Unid. 	Unid. 	€ x 100
MN-68-941	115x3x22,23	25	200	280,00
MN-68-942	125x3x22,23	25	200	299,00
MN-68-943	180x3x22,23	25	100	675,00
MN-68-945	230x3x22,23	25	50	850,00



DISCOS DE DESBASTE PARA HORMIGÓN

Saw Blades for Concrete Slab

COD	∅ mm.	Unid. 	Unid. 	€ x 100
MN-68-951	115x6x22,23	25	100	400,00
MN-68-952	125x6x22,23	25	100	480,00
MN-68-953	180x6x22,23	25	50	610,00
MN-68-955	230x6x22,23	25	50	1.240,00



DISCOS DE DIAMANTE

Diamond Saw Bladed

COD	∅ mm.	Unid. 	Unid. 	€ x 100
MN-78-132	115x22,23	10	100	1.800,00
MN-78-135	230x22,23	10	25	6.300,00



DISCOS DE DIAMANTE PROFESIONAL

Professional Diamond Saw Bladed

COD	∅ mm.	Unid. 	Unid. 	€ x 100
PO110-0115-0001	115x8x22,23	1	10	11.000,00
PO110-0230-0001	230x8x22,23	1	10	15.700,00



DESTORNILLADORES PLANOS

Flathead Screwdriver

COD	⌀ mm.	⊘ mm.		Unid.	Unid.	€ x Unid.
MN-10-551	3,5	0,6	75	12	240	5,80
MN-10-552	4,0	0,8	100	12	240	7,00
MN-10-553	5,5	1,0	125	12	120	12,00
MN-10-554	6,5	1,2	150	12	120	14,00



DESTORNILLADORES PHILIPS

Philips Screwdriver

COD	⊕ mm.		Unid.	Unid.	€ x Unid.
MN-10-561	PH0	75	12	240	8,00
MN-10-562	PH1	100	12	240	9,00
MN-10-563	PH2	100	12	240	12,00

PACK DESTORNILLADORES

Screwdrivers Pack



COD	ⓘ	Unid.	Unid.	€ x Unid.
MN-11-070	6 unidades	6	24	50,00
	⌀ 3,5x75 mm			
	⌀ 4,0x100 mm			
	⌀ 5,5x125 mm			
	⊕ PH1x100 mm			
	⊕ PH2x100 mm			
	⌀ 3,5x100 mm			



MEDIDOR DE TENSION 220V-380V

Tension Meter 220V-380V

COD	ⓘ	Unid.	Unid.	€ x Unid.
MN-17-034	200-250 ~ / 360-440~	20	80	60,00



ALICATES PLANOS

Pliers

COD		Unid.	Unid.	€ x Unid.
MN-20-056	160	1	6	39,00
MN-20-057	180	1	6	42,00
MN-20-058	200	1	6	52,00



ALICATES DE CORTE

Cutting Pliers

COD		Unid.	Unid.	€ x Unid.
MN-20-156	160	1	6	55,00



ALICATES PICO CIGÜEÑA

Pliers

COD		Unid.	Unid.	€ x Unid.
MN-20-256	160	1	6	36,00
MN-20-258	200	1	6	45,00

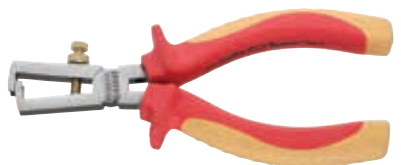

ALICATES PELACABLES

Wire Strippers

COD			Unid.	Unid.	€ x Unid.
MN-20-056	160	0,5 - 6,0	1	6	42,50



ALICATES PICO DE LORO

Adjustable Pliers

COD		Ø max. mm.	Unid.	Unid.	€ x Unid.
MN-20-650	250	30	1	6	46,00



PELACABLES

Wire Strippers

COD		Unid.	Unid.	€ x Unid.
MN-23-079	0,5 - 6,0	1	10	23,00



BROCAS PARA HORMIGÓN

Concrete Drill Bits

COD	Ø	L	Unid.	Unid.	€ x 100
MN-61-054	5	85	10	500	91,00
MN-61-056	6	100	10	500	133,00
MN-61-057	6	200	10	500	161,00
MN-61-064	8	120	10	500	189,00
MN-61-065	8	200	10	500	252,00
MN-61-070	10	120	10	500	259,00
MN-61-071	10	200	10	500	315,00
MN-61-076	12	150	10	150	399,00
MN-61-077	12	200	10	150	462,00



PACK BROCAS PARA HORMIGÓN

Concrete Drill Bits Pack

COD	Info	Ø	L	Unid.	Unid.	€ x 100
MN-61-106	5 unidades	-	-	10	100	700,00
		4 mm	75 mm			
		5 mm	85 mm			
		6 mm	95 mm			
		8 mm	115 mm			
		10 mm	120 mm			



PACK BROCAS PARA HORMIGÓN

Concrete Drill Bits Pack

COD	Info	Ø	L	Unid.	Unid.	€ x 100
MN-61-109	8 unidades	-	-	10	100	1.000,00
		3 mm	65 mm			
		4 mm	75 mm			
		5 mm	85 mm			
		6 mm	100 mm			
		7 mm	100 mm			
		8 mm	120 mm			
		9 mm	120 mm			
		10 mm	120 mm			



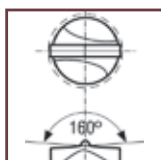

BROCAS PARA HORMIGÓN SDS+

Concrete Drill Bits SDS+

COD	Ø	Ø	Ø	Unid.	Unid.	€ x 100
MN-61-116	5	50	110	10	100	285,00
MN-61-117	5	100	160	10	100	287,00
MN-61-121	6	50	110	10	100	273,00
MN-61-122	6	100	160	10	100	273,00
MN-61-123	6	150	210	10	100	392,00
MN-61-131	8	50	110	10	100	283,00
MN-61-132	8	100	160	10	100	287,00
MN-61-133	8	150	210	10	100	392,00
MN-61-141	10	50	110	10	100	308,00
MN-61-142	10	100	160	10	100	308,00
MN-61-143	10	150	210	10	100	455,00
MN-61-147	10	410	460	10	100	1.127,00
MN-61-152	12	100	110	10	50	405,00
MN-61-153	12	150	210	10	50	497,00
MN-61-157	12	410	460	10	100	1.127,00
MN-61-163	14	150	210	10	50	574,00
MN-61-167	14	410	460	10	80	1.197,00
MN-61-177	16	410	460	10	50	1.358,00
MN-61-187	18	410	460	10	50	1.680,00
MN-61-197	20	410	460	10	50	1.792,00



PACK BROCAS SDS+ PARA HORMIGÓN

Concrete Drill Bits SDS+ Pack

COD	Unid.	Ø	Ø	Ø	Unid.	Unid.	€ x 100
MN-61-202	4 un.	-	-	-	10	80	1.600,00
		6 mm	100 mm	160 mm			
		8 mm	100 mm	160 mm			
		10 mm	100 mm	160 mm			
		12 mm	100 mm	160 mm			



CALZOS PARA VENTANAS

Glazing Blocks

COD	COLOR	mm.	Unid. 	PALET	€ x100
8601	●	1	1.000	90.000	4,50
8602	●	2	1.000	56.000	5,00
8603	●	3	1.000	56.000	5,60
8604	●	4	1.000	40.000	6,50
8605	●	5	1.000	40.000	6,75
8606	●	6	1.000	36.000	9,80
8608	●	8	1.000	24.000	12,50
8610	●	10	1.000	24.000	14,25
8612	●	12	1.000	24.000	16,80



REJILLA VERTICAL CON MARCO

Ventilation Grilles With Frame

COD	M.INTERIOR (cm)	M.EXTERIOR (cm)	PASO AIRE cm ²	Unid.	PALET	€ xUnid.
8530	9,5x22	14x28	105	60	2.520	2,86



REJILLA VERTICAL CON MARCO Y CIERRE

Ventilation Grilles With Frame + Lock

COD	M.INTERIOR (cm)	M.EXTERIOR (cm)	PASO AIRE cm ²	Unid.	PALET	€ xUnid.
8531	9,5x22	14x28	115	60	2.520	3,60

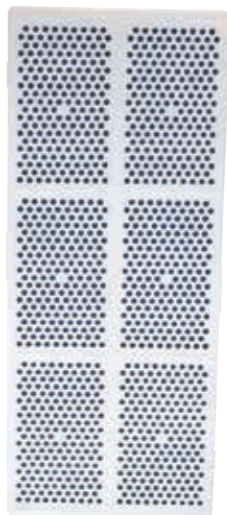

REJILLA MOSQUITERA PARA REJILLAS 8530/8531

Insect Filter for Grilles 8530/8531

COD	M.INTERIOR (cm)	M.EXTERIOR (cm)	PASO AIRE cm ²	Unid.	PALET	€ xUnid.
8535	9x21,5	-	45	200	-	1,60

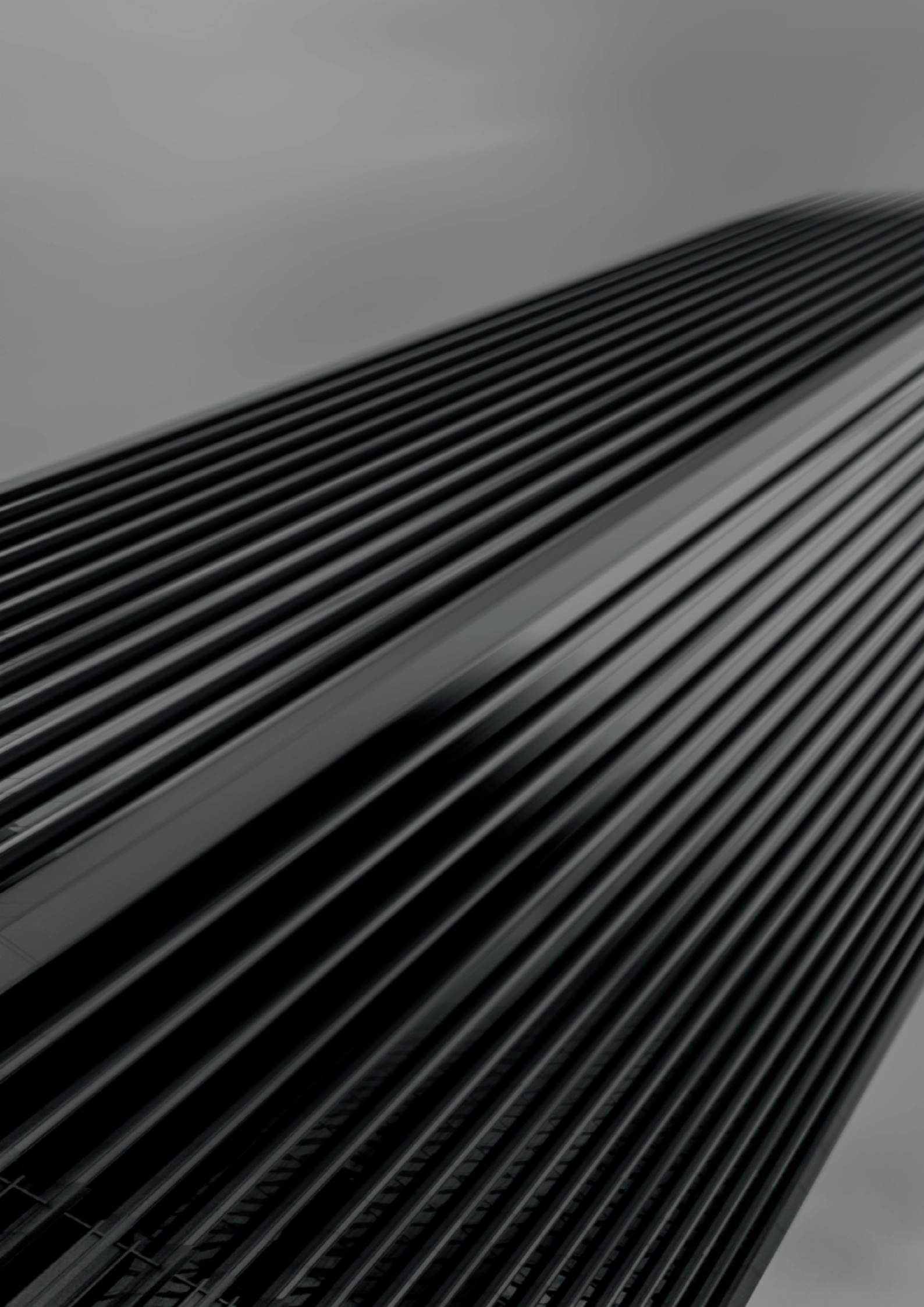



PACKAGING

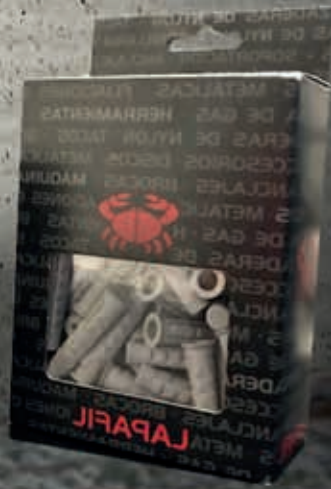

	ESPAÑOL	ENGLISH	FRANÇAIS	DEUSTCH	PORTUGUES	ITALIANO
COD	<i>Código / Color</i>	<i>Code / Colour</i>	<i>Code / Couleur</i>	<i>Kode / Farbe</i>	<i>Código / Cor</i>	<i>Codice / Colore</i>
Ref.	<i>Referencia</i>	<i>Reference</i>	<i>Référence</i>	<i>Bez-Nr.</i>	<i>Referência</i>	<i>Riferimento</i>
Unid. x	<i>Unidades por Caja</i>	<i>Units per Box</i>	<i>Unités par Boîte</i>	<i>Stück / Schachtel</i>	<i>Unidades por Caixa</i>	<i>Unità per Scatola</i>
Unid.	<i>Unidades por Embalaje</i>	<i>Units per Pack</i>	<i>Unités par Emballage</i>	<i>Stück / Packg.</i>	<i>Unidades por Embalagem</i>	<i>Unità per Imballaggio</i>
Unid.	<i>Unidades por Blister</i>	<i>Units per Blister</i>	<i>Unités par Blister</i>	<i>Stück / Blister</i>	<i>Unidades por Blister</i>	<i>Unità per Blister</i>
	<i>Blisters por Embalaje</i>	<i>Blisters per Pack</i>	<i>Blisters par Emballage</i>	<i>Blister / Packg.</i>	<i>Blisters por Embalagem</i>	<i>Blisters per Imballaggio</i>
Unid.	<i>Unidades por Bolsa</i>	<i>Units per Bag</i>	<i>Unités par Sachet</i>	<i>Stück / Beutel</i>	<i>Unidades por Saquinho</i>	<i>Unità per Sachetto</i>
Unid.	<i>Unidades por Soco</i>	<i>Units per Sock</i>	<i>Unités par Soc</i>	<i>Stück / Sock</i>	<i>Unidades por Soco</i>	<i>Unità per Sacco</i>
Mts. x	<i>Metras por Rolla</i>	<i>Metres per Roll</i>	<i>Mètres par Rouleau</i>	<i>Meter / Rolle</i>	<i>Metras por Rolo</i>	<i>Metri per rotolo</i>
	<i>Rollos por Embalaje</i>	<i>Rolls per Pack</i>	<i>Rouleaux par Emballage</i>	<i>Rollen / Packg.</i>	<i>Rolos por Embalagem</i>	<i>Rotoli per Imballaggio</i>
	<i>Toco</i>	<i>Plug</i>	<i>Cheville</i>	<i>Dübel</i>	<i>Bucha</i>	<i>Tasselli</i>
	<i>Medida Tornillo</i>	<i>Screw size</i>	<i>Dimensions vis</i>	<i>Schraubenmass</i>	<i>Medida Parafuso</i>	<i>Misura Vite</i>
	<i>Espárrago Doble Rosca</i>	<i>Double Thread Stud</i>	<i>Goujon à Filetage Double</i>	<i>Stiftschr. m. Doppelgewinde</i>	<i>Pino Dupla Rosca</i>	<i>Bullone Doppia Vite</i>
	<i>Diámetro Cabeza</i>	<i>Head Diameter</i>	<i>Diamètre de la Tête</i>	<i>Kopfdurchmesser</i>	<i>Diâmetro Cabeça</i>	<i>Diametro Testa</i>
	<i>Diámetro Rosca</i>	<i>Thread Diameter</i>	<i>Diamètre du Filetage</i>	<i>Gewindedurchmesser</i>	<i>Diâmetro Rosca</i>	<i>Diametro Spirale</i>
	<i>Varilla</i>	<i>Rod</i>	<i>Tige</i>	<i>Stange</i>	<i>Barilha</i>	<i>Stecca</i>
	<i>Gancho</i>	<i>Hook</i>	<i>Crochet</i>	<i>Haken</i>	<i>Gancho</i>	<i>Gancio</i>
	<i>Tuerca</i>	<i>Nut</i>	<i>Ecrou</i>	<i>Mutter</i>	<i>Porca</i>	<i>Dado</i>
	<i>Medidas en mm</i>	<i>Sizes in mm</i>	<i>Dimensions en mm</i>	<i>Masse in mm</i>	<i>Dimensões em mm</i>	<i>Misure in mm</i>
	<i>Medidas Cinta Perforada</i>	<i>Sizes Perforated Tape</i>	<i>Dimensions Bande Perforée</i>	<i>Lochbandmasse</i>	<i>Medidas Cinta Perfurada</i>	<i>Misure Nastro Perforato</i>
	<i>Cable mm²</i>	<i>Cable mm²</i>	<i>Câble mm²</i>	<i>Kabel qmm</i>	<i>Cabo mm²</i>	<i>Filo mm²</i>
	<i>Medida Soporte</i>	<i>Bracket Size</i>	<i>Dimension Support</i>	<i>Haltermass</i>	<i>Medida Suporte</i>	<i>Misura Supporto</i>
	<i>Tamaño Broca</i>	<i>Drill Size</i>	<i>Dimension Mèche</i>	<i>Bohrerdurchmesser</i>	<i>Tamanho Broca</i>	<i>Dimensione Trapano</i>
	<i>Diámetro</i>	<i>Diameter</i>	<i>Diamètre</i>	<i>Durchmesser</i>	<i>Diâmetro</i>	<i>Diametro</i>
PG	<i>PG</i>	<i>PG</i>	<i>PG</i>	<i>PG</i>	<i>PG</i>	<i>PG</i>
	<i>Resistencia</i>	<i>Resistance</i>	<i>Résistance</i>	<i>Festigkeit</i>	<i>Resistência</i>	<i>Resistenza</i>
	<i>Adhesivo</i>	<i>Adhesive</i>	<i>Adhésif</i>	<i>Klebstoff</i>	<i>Autocolante</i>	<i>Adesivo</i>
	<i>... de una vía / dos vías</i>	<i>... one way / two way</i>	<i>... à une voie / à deux voies</i>	<i>einwegig / zweiwegig</i>	<i>... de uma via / duas vias</i>	<i>... di una via / due vie</i>
€ x Unid.	<i>Euros por Unidad</i>	<i>Euros per Unit</i>	<i>Euros par Unité</i>	<i>Euros / Stück</i>	<i>Euros por Unidade</i>	<i>Euri per Unità</i>
	<i>Euros por Caja</i>	<i>Euros per Box</i>	<i>Euros par Caisse</i>	<i>Euros / Schachtel</i>	<i>Euros por Caixa</i>	<i>Euri per Scatola</i>
	<i>Euros por Blister</i>	<i>Euros per Blister</i>	<i>Euros par Blister</i>	<i>Euros / Blister</i>	<i>Euros por Blister</i>	<i>Euri per Blister</i>
	<i>Euros por Bolsa</i>	<i>Euros per Bag</i>	<i>Euros par Sachet</i>	<i>Euros / Beutel</i>	<i>Euros por Saquinho</i>	<i>Euri per Sachetto</i>

CONDICIONES GENERALES DE VENTA

General Sales Conditions

Las ventas que LAPAFIL, S.A., efectúe a sus distinguidos clientes se registrarán por las condiciones que se relacionan a continuación:

Precios de venta: Serán los que figuran en nuestro Catálogo o Tarifa en vigor en el momento de aceptación del correspondiente pedido. Los precios de venta pueden modificarse sin previo aviso, siendo notificados por LAPAFIL, S.A. con la mayor antelación posible.

Pedidos: Deberán cursarse preferentemente por escrito (Correo, Fax, E-Mail, etc.).

Las cantidades deberán ajustarse a envases completos de cualquiera de los artículos que aparecen en nuestro catálogo, siendo condición indispensable indicar, al menos, el Código y la Cantidad de los artículos solicitados.

Expediciones: Se efectuarán dentro de los dos días hábiles posteriores al de la recepción del mismo, salvo acuerdo puntual con el cliente o rotura de stock.

La ampliación de cualquier pedido estará condicionada por la situación del pedido anterior en el departamento de expediciones. La aceptación de una ampliación de pedido comportará la posible demora de la expedición hasta 48 horas después de la recepción de la ampliación del pedido. En caso de imposibilidad de ampliación será considerado a todos los efectos (condiciones especiales, portes, ofertas, etc.) como un nuevo pedido.

La mercancía viaja por cuenta y riesgo del comprador, salvo pacto contrario, aun cuando el envío se haga a portes pagados. El comprador tiene la obligación de examinar la mercancía en el momento de la entrega y en el caso de no poner reparos en el albarán o documento de entrega, se entenderá siempre que es de su conformidad. No serán válidas las entregas condicionadas, salvo acuerdo previo por escrito.

Descuentos: Se aplicarán sobre los precios de venta al público, de la tarifa en vigor a la fecha de aceptación del pedido.

Forma de pago: Será como máximo de 60 días.

El pago anticipado, tendrá una bonificación del 1,5%.

Vacaciones: Aquellos pagos que coincidan con la época de vacaciones, podrán tener las siguientes alternativas:

1. - Pago a su vencimiento.
2. - 50% en el mes anterior y 50% en mes posterior.
3. - Adelantar el pago 30 días, con un 1% de bonificación.
4. - Aplazar el pago 30 días, con un 1% de recargo.

Impuestos: Será aplicado el I.V.A. vigente en la fecha de la venta.

Pedidos Mínimos: Los pedidos mínimos serán de 120 euros netos.

Portes: A partir de 360 euros netos, los Portes serán Pagados en la península y Baleares. Los pedidos inferiores a esta

cantidad se considerarán como a Portes Debidos. En el caso de que sea de interés para el cliente, y previa autorización, se podrá remitir la mercancía a Portes Pagados y se cargarán en la Factura correspondiente.

En el caso de enviar la mercancía a Portes Pagados, esta se expedirá por los medios elegidos por LAPAFIL S.A. Cualquier otro medio que se indique, irá a cargo del Cliente.

Devoluciones: Cualquier reclamación debe de realizarse en un plazo no superior a los 15 días después de la entrega de la mercancía, debiendo informar a LAPAFIL S.A. de las causas de la no conformidad del producto, teniendo 15 días más para concretar la devolución.

Cualquier devolución debe ser aceptada expresamente por el Departamento Comercial de LAPAFIL S.A. y cumplir con los siguientes requisitos:

Devolución a LAPAFIL S.A. a Portes pagados.

Envases y Productos completos y sin deterioro.

Productos vigentes en el catálogo en vigor.

Los Precios aplicables para la devolución serán los que figuren en la correspondiente factura de compra.

En el caso de que la devolución de materiales se produzca por causas o defectos no imputables a LAPAFIL S.A., se penalizará un 15% sobre el valor neto de la devolución en concepto de costes de manipulación y reacondicionamiento.

Reservas de Dominio: Hasta que LAPAFIL S.A. no haya percibido el pago total de la mercancía entregada al cliente, LAPAFIL S.A. se reserva el dominio sobre dicha mercancía.

Fueros: Para cuantas cuestiones y discrepancias se deriven o puedan derivarse de cualquier operación, incluso reclamación judicial de precio, ejecución de letras de cambio, cheques, talones o pagarés, comprador y vendedor se someten expresamente a la competencia de los Jueces y Tribunales de Barcelona, con renuncia de cualquier otro fuero que pudiera corresponderles.

Costas y Gastos: Los gastos y costas judiciales, incluso honorarios de Abogados y derechos de Procurador, serán de cuenta de la parte contratante que hubiera dado lugar a ellos por incumplimiento de estas condiciones generales de venta o del contrato general.

Derecho Supletorio: Los contratos de venta se registrarán por lo aquí convenido y en su defecto por las normas del código de comercio.

LAPAFIL, S.A. No aceptará otras cláusulas aunque figuren en los pedidos o escritos de sus clientes, salvo pacto entre las partes debidamente autorizado por el departamento de administración / contable, o gerencia.

El hecho de cursar un Pedido a LAPAFIL S.A. implica el conocimiento de las presentes cláusulas por parte de los Sres. Clientes.

